

Cable trunking SES with slots and base punching



GF-DIN-A7/5



GF-DIN-A7/5

Material:	Rigid PVC quality 9051 LF
Colours:	grey RAL7030 - black
Operating temperatures:	-5 to +65°C
Volume resistivity:	10 ¹⁵ Ω.cm
Dielectric strength:	15kV/mm
Flame resistance:	V0 UL94
Standard length:	2 meters
Double sided adhesive:	upon request
Minimum delivery:	1 complete packing (with lids)



Example for order:

Colours: 013 grey 010 black

code group	detail article	code colour
0845	x x x x	x x x

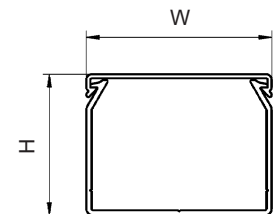

type	trunking art. no.	m	outside dim.		cables per trunking (filling 50%)			lids (alone) art. no.	m
			H mm	W mm	1 mm ²	1,5 mm ²	2,5 mm ²		
GF-DIN-A7/5 25 x 25	0845 0031 ***	48	23	23	25	21	17	0845 0640 ***	48
GF-DIN-A7/5 37,5x 25	0845 0041 ***	48	35,5	23	44	36	30	0845 0640 ***	48
GF-DIN-A7/5 37,5x 37,5	0845 0051 ***	24	35,5	35,5	74	61	51	0845 0645 ***	24
GF-DIN-A7/5 37,5x 50	0845 0061 ***	24	35,5	48	105	86	72	0845 0650 ***	24
GF-DIN-A7/5 50 x 25	0845 0131 ***	48	48	23	62	51	42	0845 0640 ***	48
GF-DIN-A7/5 50 x 37,5	0845 0141 ***	24	48	35,5	104	85	71	0845 0645 ***	24
GF-DIN-A7/5 50 x 50	0845 0151 ***	24	48	48	146	120	100	0845 0650 ***	24
GF-DIN-A7/5 50 x 75	0845 0152 ***	24	48	73	230	189	158	0845 0655 ***	24
GF-DIN-A7/5 50 x 100	0845 0153 ***	12	48	98	315	259	216	0845 0630 ***	12
GF-DIN-A7/5 50 x 125	0845 0154 ***	12	48	123	399	328	274	0845 0665 ***	12
GF-DIN-A7/5 75 x 25	0845 0211 ***	48	73	25	101	83	69	0845 0640 ***	48
GF-DIN-A7/5 75 x 37,5	0845 0221 ***	24	73	35,5	161	132	111	0845 0645 ***	24
GF-DIN-A7/5 75 x 50	0845 0231 ***	24	73	48	227	186	156	0845 0650 ***	24
GF-DIN-A7/5 75 x 75	0845 0241 ***	24	73	73	358	294	246	0845 0655 ***	24
GF-DIN-A7/5 75 x 100	0845 0251 ***	12	73	98	489	402	336	0845 0630 ***	12
GF-DIN-A7/5 75 x 125	0845 0261 ***	12	73	123	620	509	426	0845 0665 ***	12
GF-DIN-A7/5 100 x 50	0845 0286 ***	24	100	48	304	250	209	0845 0650 ***	24
GF-DIN-A7/5 100 x 75	0845 0296 ***	12	100	73	484	398	333	0845 0655 ***	24
GF-DIN-A7/5 100 x 100	0845 0268 ***	12	100	98	671	551	461	0845 0630 ***	12
GF-DIN-A7/5 100 x 150	0845 0269 ***	12	100	150	1043	856	716	0845 0637 ***	12

Accessories:

- C3/1-01
- C3/1-01
- C3/1-02
- C3/1-02
- C3/5-01
- C3/6-01
- C3/6-01
- D4/6-01

New

GF-DIN-A7/5

H = 25 mm

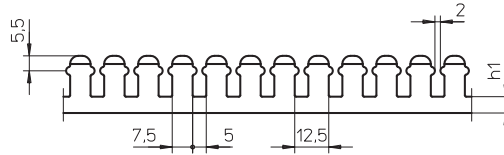
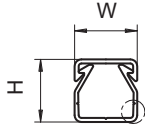

W = 25, 37,5 and 50 mm

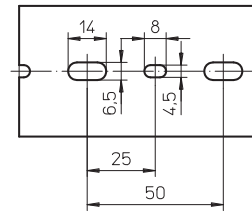

H = 37,5 mm
H = 50 mm

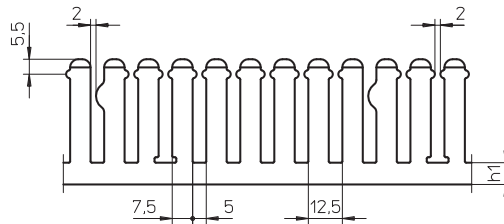
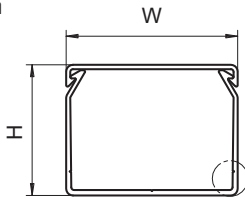

W = 75, 100, 125 and 150 mm

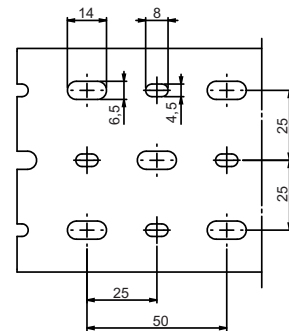

H = 75 mm

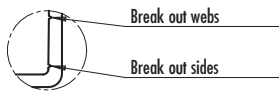
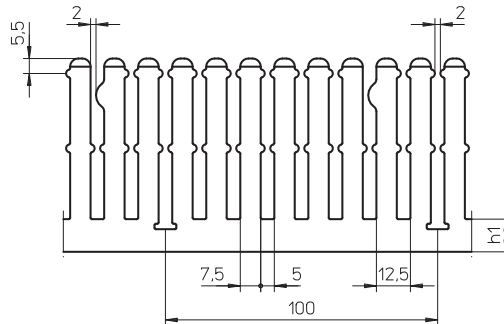
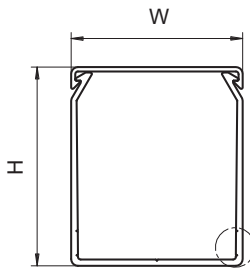

H = 100 mm

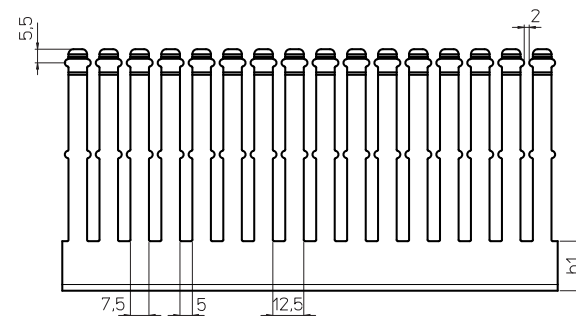
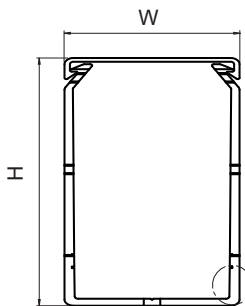

Base punching to NF EN 50085

H (mm)	25	37,5	50	75	100
h1 (mm)	5	7	9	11	20

Cable trunking SES halogene free with slots and base punching





GF-DIN-SH-A7/5

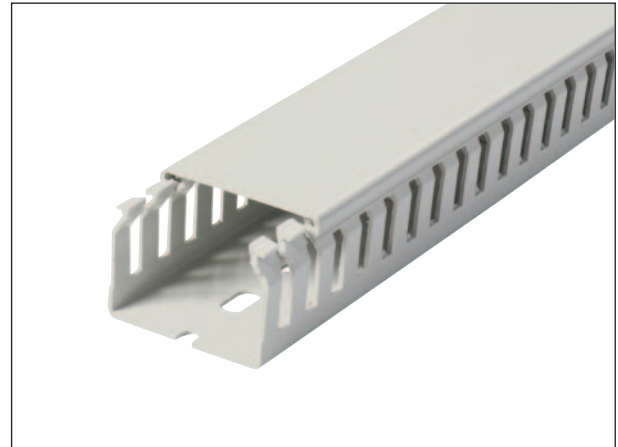

GF-DIN-SH-A7/5

Material:	PC/ABS
Colour:	light grey RAL7035
Operating temperatures:	-25 to +90°C
Volume resistivity:	10 ¹⁵ Ω.cm
Dielectric strength:	35 kV/mm
Flame resistance:	V0 UL94
Specification:	EN 45545-2 NF F16-101/102 - DIN 5510-2 halogene free
Standard length:	2 meters
Double sided adhesive:	upon request
Minimum delivery:	1 complete packing (with lids)



type	trunking art. no.	 m	outside dim.		cables per trunking (filling 50 %)			lids (alone)	
			H mm	W mm	1 mm ²	1,5 mm ²	2,5 mm ²	art. no.	m
GF-DIN-SH-A7/5 25 x 25	0848 0031 013	48	23	23	25	21	17	0848 0640 013	12
GF-DIN-SH-A7/5 37,5x 25	0848 0041 013	48	35,5	23	44	36	30	0848 0640 013	12
GF-DIN-SH-A7/5 37,5x 37,5	0848 0051 013	24	35,5	35,5	74	61	51	0848 0645 013	12
GF-DIN-SH-A7/5 37,5x 50	0848 0053 013	24	35,5	48	105	86	72	0848 0650 013	12
GF-DIN-SH-A7/5 50 x 25	0848 0131 013	48	48	23	62	51	42	0848 0640 013	12
GF-DIN-SH-A7/5 50 x 37,5	0848 0141 013	24	48	35,5	104	85	71	0848 0645 013	12
GF-DIN-SH-A7/5 50 x 50	0848 0151 013	24	48	48	146	120	100	0848 0650 013	12
GF-DIN-SH-A7/5 50 x 75	0848 0152 013	24	48	73	230	189	158	0848 0655 013	12
GF-DIN-SH-A7/5 50 x 100	0848 0153 013	12	48	98	315	259	216	0848 0660 013	12
GF-DIN-SH-A7/5 75 x 25	0848 0211 013	48	73	23	101	83	69	0848 0640 013	12
GF-DIN-SH-A7/5 75 x 37,5	0848 0221 013	24	73	35,5	161	132	111	0848 0645 013	12
GF-DIN-SH-A7/5 75 x 50	0848 0231 013	24	73	48	227	186	156	0848 0650 013	12
GF-DIN-SH-A7/5 75 x 75	0848 0241 013	24	73	73	358	294	246	0848 0655 013	12
GF-DIN-SH-A7/5 75 x 100	0848 0251 013	12	73	98	489	402	336	0848 0660 013	12
GF-DIN-SH-A7/5 75 x 125	0848 0261 013	12	73	123	620	509	426	0848 0665 013	12

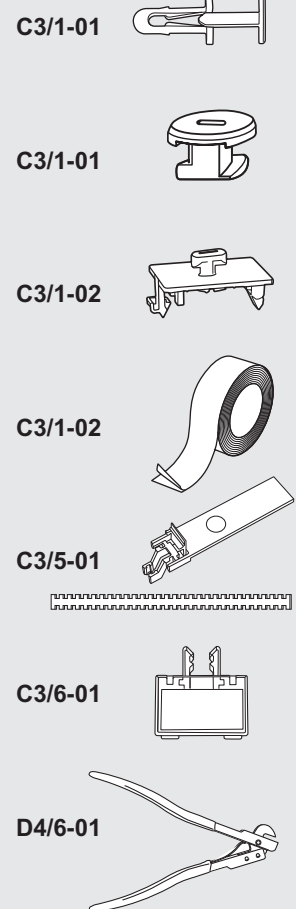
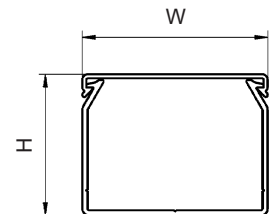

Cable trunking SES
with slots and base punching



GF-DIN-SH-A7/5



GF-DIN-SH-A7/5

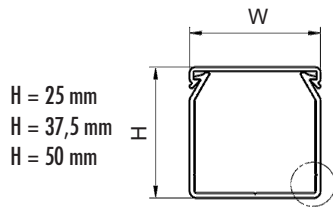

H = 25 mm
H = 37,5 mm
H = 50 mm

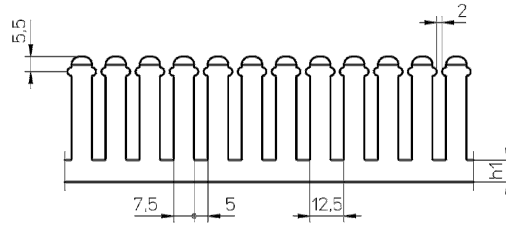

W = 25, 37,5 and 50 mm

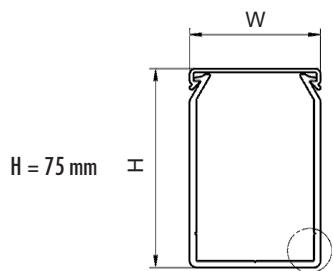
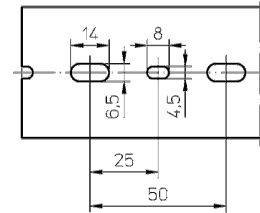

H = 75 mm

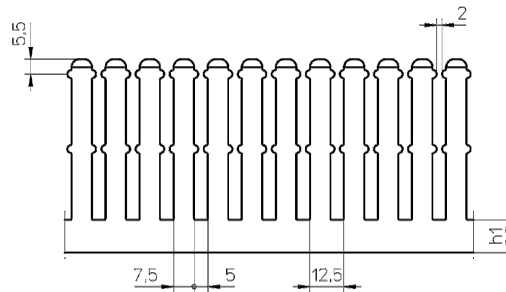

W = 75, 100 and 125 mm

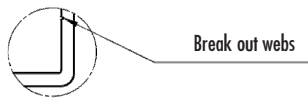
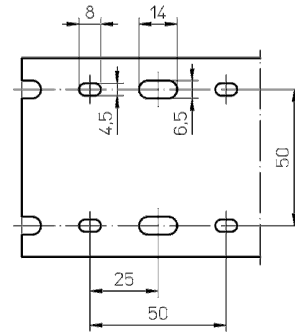

Break out webs

Base punching to DIN 43659

H (mm)	25	37,5	50	75
h1 (mm)	6	8	8	12



Cable trunking SES with slots and base punching



GF-DIN-C-A12/8



GF-DIN-C-A12/8

Material:	Rigid PVC quality 9051 LF
Colour:	grey RAL7030 - black
Operating temperatures:	-5 to +65°C
Volume resistivity:	10 ¹⁵ Ω.cm
Dielectric strength:	15 kV/mm
Flame resistance:	V0 UL94
Standard length:	2 meters
Double sided adhesive:	upon request
Minimum delivery:	1 complete packing (with lids)

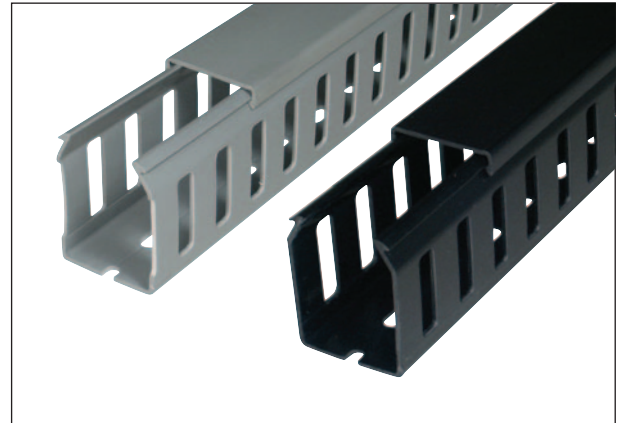

Example for order:

Colours: 013 010

code group	detail article	code colour
0845	x x x x	x x x

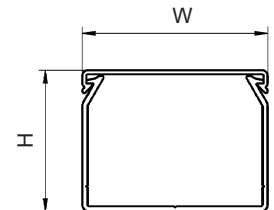

type	trunking art. no.	m	outside dim.		cables per trunking (filling 50%)			lids (alone) art. no.	m	
			H mm	W mm	1 mm ²	1,5 mm ²	2,5 mm ²			
GF-DIN-C-A12/8	37,5x 25	0845 0046 ***	48	35,5	23	44	36	30	0845 0640 ***	48
GF-DIN-C-A12/8	37,5x 37,5	0845 0056 ***	24	35,5	35,5	74	61	51	0845 0645 ***	24
GF-DIN-C-A12/8	37,5x 50	0845 0066 ***	24	35,5	48	105	86	72	0845 0650 ***	24
GF-DIN-C-A12/8	50 x 25	0845 0136 ***	48	48	23	62	51	42	0845 0640 ***	48
GF-DIN-C-A12/8	50 x 37,5	0845 0146 ***	24	48	35,5	104	85	71	0845 0645 ***	24
GF-DIN-C-A12/8	50 x 50	0845 0166 ***	24	48	48	146	120	100	0845 0650 ***	24
GF-DIN-C-A12/8	50 x 75	0845 0167 ***	24	48	73	230	189	158	0845 0655 ***	24
GF-DIN-C-A12/8	50 x100	0845 0168 ***	12	48	98	315	259	216	0845 0630 ***	12
GF-DIN-C-A12/8	50 x125	0845 0169 ***	12	48	123	399	328	274	0845 0665 ***	12
GF-DIN-C-A12/8	75 x 25	0845 0216 ***	48	73	25	101	83	69	0845 0640 ***	48
GF-DIN-C-A12/8	75 x 37,5	0845 0226 ***	24	73	35,5	161	132	111	0845 0645 ***	24
GF-DIN-C-A12/8	75 x 50	0845 0236 ***	24	73	48	227	186	156	0845 0650 ***	24
GF-DIN-C-A12/8	75 x 75	0845 0246 ***	24	73	73	358	294	246	0845 0655 ***	24
GF-DIN-C-A12/8	75 x100	0845 0256 ***	12	73	98	489	402	336	0845 0630 ***	12
GF-DIN-C-A12/8	75 x125	0845 0266 ***	12	73	123	620	509	426	0845 0665 ***	12

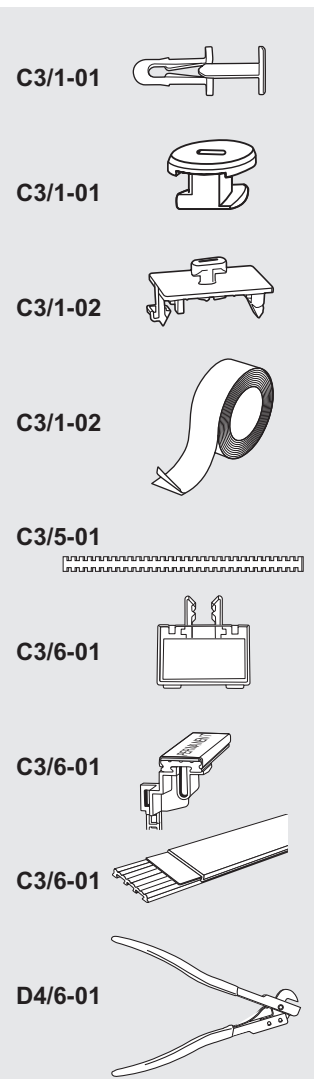

GF-DIN-C-A12/8

