

Part number

PEW 12564 PP



Wall-mounting socket outlet, PLUSO series, 3 poles + PE, 6 h (red), 125 A, 380 ÷ 415 V

Product description

Product type	Socket Wall-mounting
Series	PEW...PP, PLUSO
N. of poles	3 poles + 
Clock position	6

Technical data

Current	125 A
Voltage	380 ÷ 415 V
IP degree of protection	IP67

Further technical details

Weight	3.906,00 g
Operating temperature range (min, max)	-25°C ... +40°C

Material properties

Colour	RAL 7035 grey, RAL 3000 red
RoHs conformity	Compliant with exemption 6(c): copper alloy containing up to 4% lead by weight
China RoHs - EFUP	50
REACH SVHC substances	Yes Lead
SCIP number	Ca7de37f-add8-4b77-9861-279c94903ade

Approvals / Standards

Reference standard	EN 60309-1 and -2
---------------------------	-------------------

General ordering information

EAN13 code	8015747070379
-------------------	---------------

Packaging Information

Packaging length	170,00 mm
Packaging height	190,00 mm
Packaging width	400,00 mm
Packaging weight	4,20 kg
Packaging volume	12,92 dm ³
Packaging description	Carton box
Packaging quantity	1 Pcs
Packaging EAN code	8015747070386

Part number

PEW 12564 PP



Catalogue drawings

(63A) PEW ... PP

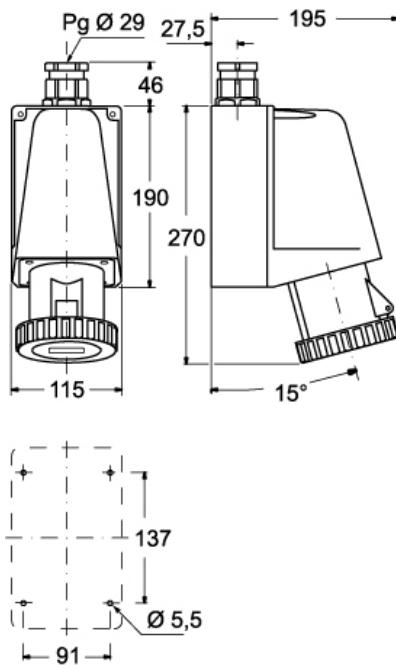

(125A) PEW ... PP

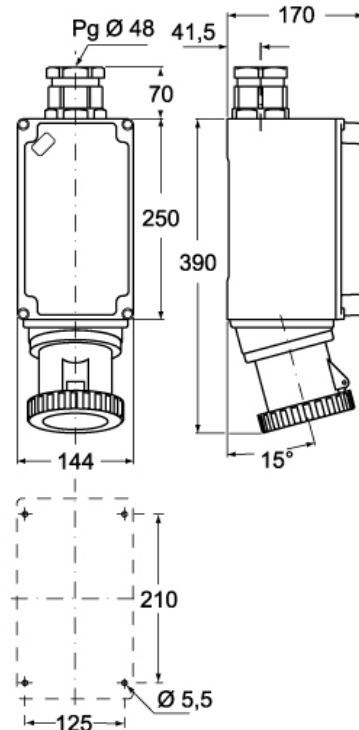

Notes

Dimensions shown in mm are not binding and may be changed without notice.

- Compliant with EN 60309-1 and -2
- Enclosure, insert and spring lid in insulating, thermoplastic, self-extinguishing material
- RAL 7035 grey enclosure, spring lid colour coded according to the operating voltage
- PE...PP types (IP44), spring lid, entry with threaded grommet (replaceable with a cable gland)
- PEW...PP types (IP67), spring lid with locking ring and gasket, entry with cable gland
- Terminals with retained screws
- 63A, 125A: with pilot contact
- Nickel-plated contacts, available on request for 16A and 32A (standard on 63A and 125A). For the code of products with nickel-plated contacts (socket holes, plug pins), add "N" to the pre-code of the corresponding standard product code; for example: PE becomes PEN and PEW becomes PEWN.
- 125A: with terminal block for the anchoring of incoming cables, already connected to socket
- IP44 and IP67 degrees of protection (EN 60529)