

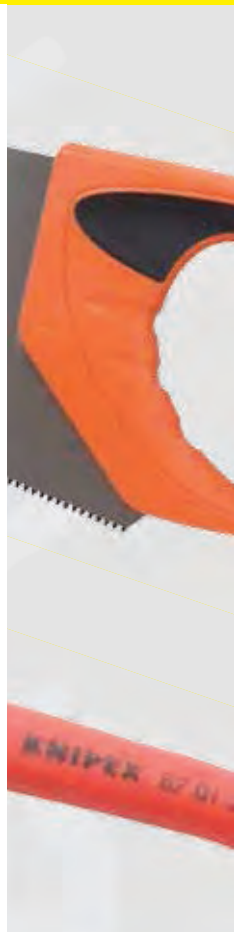

U.K. Office: +44 (0)141 941 3689 | sales@expresselectrical.co.uk | www.expresselectrical.co.uk
U.A.E. Office: +971 (0)4 887 5570 | info@expresselectrical.ae | www.expresselectrical.ae

TOOL CATALOGUE



LEADING BRANDS | INNOVATION | VALUE FOR MONEY

CONTENTS

Welcome to the Tool Catalogue and thank you for supporting your local independent tool and fixings merchant.

The Tool Catalogue brings together a unique collection of market leading brands across the hand tools range. The collection is aimed at the professional user, be it in the general building trade, plumbing, electrical or hire sectors.

The hand tool range is represented by the “who’s who” of the trade, all the leading brands are there. It is complemented with the Hardman brand - “work tough tools” which are designed for the professional tradesman with full consideration of price and value creating a real cost effective choice.

The layout of the catalogue is straight forward making the finding and selection of product easy.



Adhesives	1
Auger Bits	4
Axe	6
Batteries	7
Bolt Cutters	8
Builders & Contractors	9
Chains	13
Clamps / Cramps & Vices	14
Contractors	19



Flat Wood Bits	48
Gardening	51
Hammers	52
Handsaws	56
Holesaws	63
Knives & Blades	67
Laser Levels	72
Levels	74
Locking Pliers	77



Plumbing	118
Precision Engineering	125
Punches	131
Riveters	134
Safety Wear	136
Screwdriver	143
Snips & Shears	148
Sockets	149
Socket Sets	162



Countersinks & Hinge Boring Bits	24
Decorating	25
Detectors	27
Diamond Blades	30
Dry Core Drills	31
Drywall Range	32
Electrical Equipment	36
Engineers	38
Files & File Handles	43

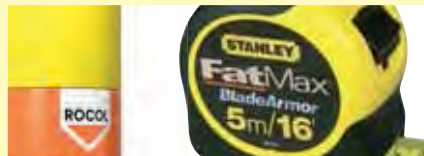

Lubricants	81
Lubricants Accessories	89
Magnets	91
Marking Out	93
Measuring	97
Padlocks	103
Planes	106
Plastering, Trowels & Accessories	109
Pliers	112



Soldering Irons	165
Spanners	166
Staplers & Staples	170
Storage	172
Tiling	178
Torches & Lanterns	182
Wood Chisels	186
Wrenches	188
Notes	192



ADHESIVES

Gorilla Glue 4oz

- 115ml/4oz Gorilla Glue Merchandiser

8 Pack Counter Tray - Code: 8300TGC11508

100% waterproof

Incredibly strong and versatile

Strainable, paintable and easily sanded

Open working time of 20 minutes

Acid-free & non-toxic when cured

Expands 3 to 4 times its size so only small amount required



Gorilla Glue 8oz

- 255ml/8oz Gorilla Glue
- 6 Bottles Gorilla Glue Merchandiser

Code: 8300TGC25006



Gorilla Glue 2oz

- 60ml/4oz Gorilla Glue Merchandiser

5 Pack Counter Tray

Code: 8300TGC6005

10 Pack Counter Tray

Code: 8300TGC6010



Arrow Glue Stix

- Set in 30 to 60 seconds
- For crafts hobbies and general repairs
- For woodworking, ceramics, leather, canvas, fabrics, cardboards, plastics, metal
- Press surfaces together within 15 seconds

10" x 1/2" Pack of 12 - Code: 4937TAP10

10" x 1/2" Bulk - Code: 4937TAP2000

4" x 1/2" Pack of 6 - Code: 4937TAP5

4" x 1/2" Pack of 24 - Code: 4937TBAP5



Arrow All Purpose Mini Glue Stix

4" Pack of 12 - Code: 4937TMG12

4" Pack of 24 - Code: 4937TMG24



MRO FIX Anaerobic Activator Spray

- 200ml Anaerobic Activator Spray

Code: 1636TANAC1200



MRO FIX Cyanoacrylate Activator Spray

- 200ml Cyanoacrylate Activator Spray

Code: 1636TCAAC1200



MRO FIX Cyanoacrylate Debonder

- 28g Cyanoacrylate Debonder

Code: 1636TCADB128



MRO FIX Steel Epoxy Putty Stick

- 4oz Steel Epoxy Putty Stick

Code: 1636TESGRY178



ADHESIVES



MRO FIX Fast Cure Gasket Maker

- 50ml Fast Cure Gasket Maker

Code: 1636TGMFC150



MRO FIX Solvent Cleaner/Degreaser

- 400ml Solvent Cleaner/Degreaser

Code: 1636TGPCD1400



MRO FIX Fast Cure Hydraulic Sealant

- 50ml Fast Cure Hydraulic Sealant

Code: 1636TPSHS150



MRO FIX Slow Cure Pipe Sealant

- 50ml Slow Cure Pipe Sealant

Code: 1636TPSSC150



MRO FIX Medium Viscosity Retainer

- Medium Viscosity Retainer

10ml - Code: 1636TRTMV110
50ml - Code: 1636TRTMV150



MRO FIX General Purpose Super Bond LV

- General Purpose Super Bond LV

5g - Code: 1636TSBLV105
20g - Code: 1636TSBLV120
50g - Code: 1636TSBLV150



MRO FIX Medium Strength Nutlocker

- Medium Strength Nutlocker

10ml - Code: 1636TTLNU110
50ml - Code: 1636TTLNU150



MRO FIX Low Strength Screwlocker

- Low Strength Screwlocker

10ml - Code: 1636TTLSC110
50ml - Code: 1636TTLSC150



MRO FIX High Strength Studlocker

- High Strength Studlocker

10ml - Code: 1636TTLSD110
50ml - Code: 1636TTLSD150



Arrow Glue Guns

- Mains operated
- Exclusive clutch prevents glue run on
- Easy squeeze lever for precise glue control
- Integrated drip tray with stand

Mini Glue Gun - Code: 4936TMT100
Trigger Feed Glue Gun - Code: 4936TTR200
Trigger Feed Glue Gun - 240v - Code: 4936TTR550



TR550



MT100



TR200

Hardman Skeleton Gun

- Steel skeleton frame
- Length 280mm/11"
- Accepts a wide range of sealant and adhesives tubes

Code: AT11001



Everbuild General Purpose Silicone

- General purpose silicone is a high modulus silicone that adheres to most smooth and non-porous materials
- Contains an anti-fungal compound to prevent mould growth in areas of high humidity
- Forms a permanently flexible rubber seal

310ml - Code: **3010T12GP**_____

Available in: Clear - Black - Brown - Grey - White



Everbuild Forever White Silicone C3

- Forever white is a superior silicone sealant that is permanently waterproof and flexible and ideal for sealing: shower bases and cubicles, wet rooms, around baths, sinks and basins
- It is also ideal for use in kitchens and utility rooms and for sealing around window and frames

310ml - Code: **3010TFOREVERWE**

Available in: White - Clear



Everbuild Pinkgrip

- Pinkgrip will stick just about anything on a building site that needs sticking
- It's amazing grabbing strength not only removes the need to pin under the workpiece to prevent slumping, but its revolutionary initial 'Direct bond' eliminates the need for double stick methods

350ml - Code: **3012TPINKGRIP**



Everbuild Stixall Extreme Power

- Stixall Extreme power is the ultimate combined building adhesive and sealant, based on hybrid polymer technology, with the most Extreme power to both bond and seal virtually EVERYTHING to ANYTHING in virtually all conditions, even under water or in the rain

310ml - Code: **3012TSTIX**

Available in: Crystal Clear - White - Black - Brown - Grey



Everbuild Instant Nails

- Instant nails is a high strength solvent free gap filling multi-use adhesive that provides a quick grab and replaces mechanical fixings in many home improvement applications
- Dries white and may be overpainted if required

310ml - Code: **3012TINST**



Everbuild One Hour Caulk White C3

- 125 One Hour Caulk is a fast drying flexible decorators filler and sealant that remains permanently flexible
- Can be overpainted with most paint types or covered over with wallpaper; no sanding down required

310ml - Code: **3010T125**

Available in: White - Brown - Magnolia



Everbuild Wonder Wipes

- The original Multi-Use Wonder Wipes specially formulated for building and allied trades
- Cleans hands, tools and work surfaces, particularly useful for removing stubborn sealant; silicone, bitumen and foam when there is no water on site
- Contains powerful anti-bacterial additive in addition to lanolin to condition skin

Tub of 100 - Code: **3018TWIPE80**



Electrical Insulation Tape

- Flame retardant
- Manufactured to BS3924

Code: **7031T**_____

Available in: Black - Blue - Green - Red - White - G/Yellow



Barrier Tape

- Non adhesive, strong and durable PVC tape
- Black/Yellow

Code: **7030TBTBKYW**



Cloth Tape

- Heavy duty and waterproof

Black - Code: **7030TCL004150B**

Silver - Code: **7030TCL004150S**



Hazard Warning Tape

- Adhesive backed
- For marking hazardous areas
- Black/Yellow

Code: **7031THWBKYW**

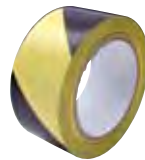

Brown Parcel/Opp Tape

- Self adhesive for parcels
- Brown

Code: **7030TBP0015**



PTFE Tape

- For sealing screw threads in pipe work

1/2" x 40ft - Code: **6143T5400**



Masking Tape

19mm x 50mtr - Code: **7030TMT005219**

25mm x 50mtr - Code: **7030TMT005225**

38mm x 50mtr - Code: **7030TMT005238**

50mm x 50mtr - Code: **7030TMT005250**

75mm x 50mtr - Code: **7030TMT005275**



AUGER BITS



Bahco Combination Auger Bits

- Auger bit for drilling in wood
- One section of tang with hexagonal shank for firm grip in the chuck. Additional 15mm long section with four flat sides, suitable for hand braces
- Spirals with Levin pattern
- Lacquered for rust protection



Code	Size
6175T49	6mm x 160mm
6175T54	8mm x 170mm
6175T56	10mm x 190mm
6175T58	12mm x 190mm
6175T59	13mm x 190mm
6175T60	14mm x 200mm
6175T62	16mm x 200mm
6175T63	18mm x 200mm
6175T84	19mm x 200mm
6175T64	20mm x 210mm
6175T65	22mm x 210mm
6175T66	24mm x 210mm
6175T67	25mm x 210mm
6175T687	28mm x 210mm
6175T69	30mm x 210mm
6175T692	32mm x 210mm

Bahco Combination Auger Bits Long Series

- Extra long auger bit for drilling in wood
- One section of tang with hexagonal shank for firm grip in the chuck. Additional 15mm long section with four flat sides, suitable for hand braces
- Spirals with Levin pattern
- Lacquered for rust protection



Code	Size
6176T49	6mm x 400mm
6176T54	8mm x 400mm
6176T56	10mm x 400mm
6176T58	12mm x 400mm
6176T59	13mm x 400mm
6176T60	14mm x 400mm
6176T62	16mm x 400mm
6176T63	18mm x 400mm
6176T84	19mm x 400mm
6176T64	20mm x 400mm
6176T65	22mm x 400mm
6176T66	24mm x 400mm
6176T67	25mm x 400mm
6176T687	28mm x 400mm
6176T692	32mm x 400mm

Code	Size
AT31001	6mm
AT31003	10mm
AT31004	13mm
AT31005	16mm
AT31006	19mm
AT31007	22mm
AT31008	25mm
AT1008A	29mm
AT31009	32mm
AT31010	35mm
AT31011	38mm

Hardman Combination Auger Bits

- Combination auger bits for dual powertool and hand brace use
- Precision holes in wood
- Hardened Tool Steel



Hardman Flat & Auger Bit Set

- 13 piece set contains

Flat wood bits

13mm, 16mm, 19mm, 22mm, 25mm & 32mm quick release extension bar

Auger bits

10mm, 13mm, 16mm, 19mm, 22mm & 25mm

Code: AT33020

AXE



Hardman 1 1/2lb Hand Axe

- Comes complete with blade guard

Code: AT22005

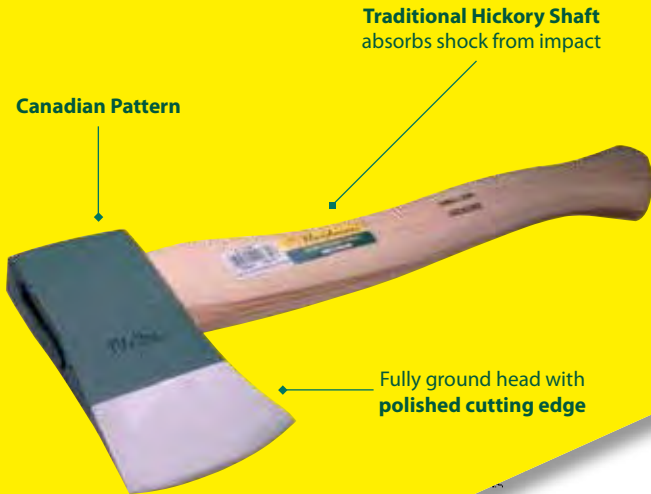

Hardman All Steel Axe

- Fully ground head with polished cutting edge
- Forged from one piece quality steel with mirror finish
- Innovative bi-material handle for a sure, firm and comfortable grip
- Comes complete with blade guard

Code: AT22006



Stanley Steelmaster Axe

- Fully Hardened and tempered carbon steel head for long life
- Ergonomic, non-slip, solvent resistant grip
- Heat treated seamless tubular steel shaft for improved safety
- Protective head cover with belt clip

Code: 2728T151030



Stanley Fatmax Anti-vibe Drywall Hammer

- Specially designed for the installation of drywall/plasterboard
- Special blade-edge ideal for removing old material and marking cut outs required for Electrical outlets and switches
- Patented Anti-vibe Technology reduces vibration transmitted to wrist and elbow
- One-piece forged construction for strength and durability
- Offset striking face to facilitate overhead working
- Checker face for non-slip nail striking

Code: 2737T154015



Estwing Sportsman Axe

- Leather grip
- One piece head and shaft
- Full polished
- Sheath included

Code: 7124T0314L



Stanley Fatmax Carpenters Hatchet

- Dual function hammer for cutting wood and or driving stakes or unhardened nails
- Suitable for wide variety of trades including carpentry, framing and roofing
- Patented Anti-vibe Technology reduces vibration transmitted to wrist and elbow
- One-piece forged construction for strength and durability

Code: 2737T154023

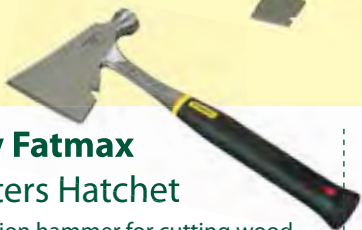

Estwing Blue Vinyl Grip

Code: 7126T0309V



Bahco Felling Axe

4lb Felling Axe Code: 6368T400



Hardman Felling Axe

- Traditional hickory shaft absorbs shock from impact
- Fully ground head with polished cutting edge
- Comes complete with blade guard

31/2lb Felling Axe Code: AT22001

41/2lb Felling Axe Code: AT22002

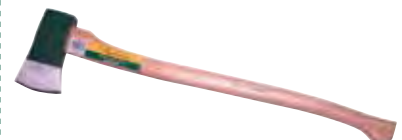

Duracell AA Cell

Code: DURLR6

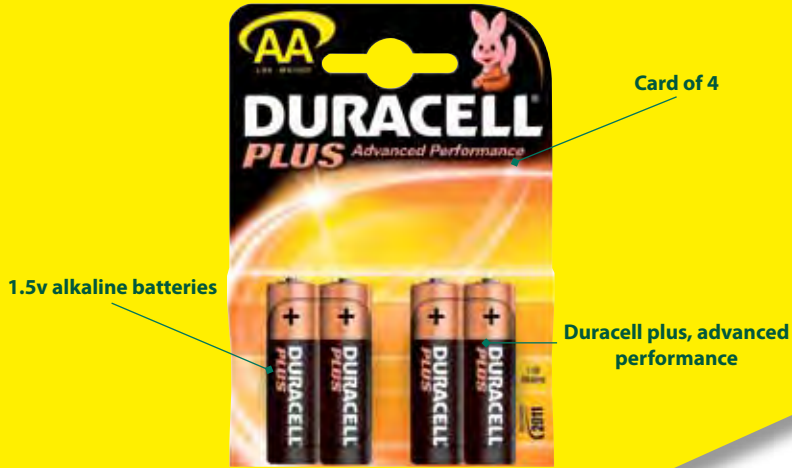

Duracell Procell Batteries (Boxed) Bulk

- PROCELL Batteries are dependable, long-lasting Duracell Batteries
- They are manufactured to the same high standards as the famous 'Copper and Black' products
- Conveniently packaged in boxes of ten
- PROCELL Batteries are not available in any high street outlet and are available exclusively to industrial users

AA Cell Box of 10 - **Code: DURLR6BULK**
 AAA Cell Box of 10 - **Code: DURLR03BULK**
 C Cell Box of 10 - **Code: DURLR14BULK**
 D Cell Box of 10 - **Code: DURLR20BULK**
 9v Box of 10 - **Code: DURCLR61BULK**

BATTERIES



Duracell AAA Cell

- 1.5V alkaline
- Duracell plus, advanced performance

Card of 4 - **Code: DURLR03**



Duracell C Cell

- 1.5V alkaline
- Duracell plus, advanced performance

Card of 2 - **Code: DURLR14**



Duracell D Cell

- 1.5V alkaline
- Duracell plus, advanced performance

Card of 2 - **Code: DURLR20**



Duracell 9V Battery

- 9V alkaline
- Duracell plus, advanced performance

Card of 1 - **Code: DURCLR61**

Unilite 6V Square Battery

- Heavy duty zinc chloride battery
- 0% cadium, 0% mercury added

Code: 8120T6V



BOLT CUTTERS



Irwin Record Bolt Cutters - Centre Cut

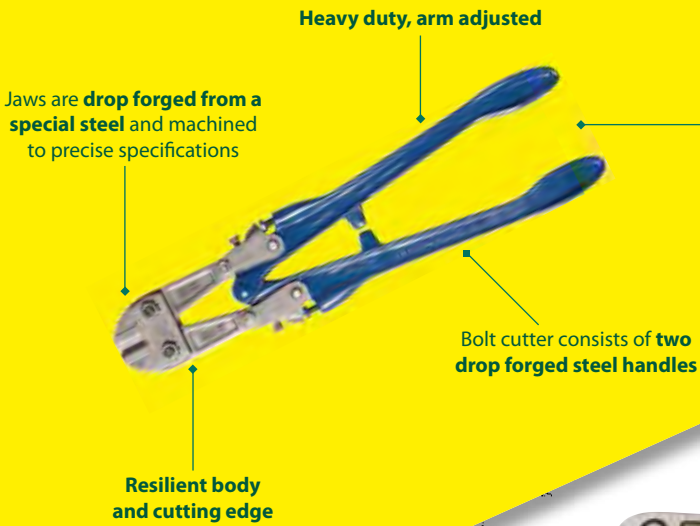

Code	Size
3547T1400	14"
3547T1800	18"
3547T2400	24"
3547T3000	30"
3547T3600	36"
3547T4200	42"

Irwin Record Replacement Jaws

- Replacement jaws available for TJ914H - TJ942H



Irwin Record 24" Bolt Cutter - Angle Cutting

- Heavy Duty, arm adjusted
- Two drop-forged steel handles, which open and close the jaws through a compound action
- The jaws are drop forged from a special steel and machined to precise specifications, this produces a resilient body and rigid cutting edge
- 30° angle jaws



Code: 3550T3000

Hardman Bolt Croppers

- Suitable for cutting mild steel bars & bolts, chains and metal sections

- 18" - Code: AT55001
- 24" - Code: AT55002
- 30" - Code: AT55003
- 36" - Code: AT55004



Unior Bolt Cutters - Centre Cut

- Cuts special tool steel, drop forged, hardened and tempered
- Cutting edges separately induction hardened
- Ergonomically shaped tube steel handles, lacquered and heavy duty
- Shock absorbers on the joints absorb shocks on the handles which happen when cutting reinforced rod

- 12" - Code: 6040T1200
- 14" - Code: 6040T1400
- 18" - Code: 6040T1800
- 24" - Code: 6040T2400
- 30" - Code: 6040T3000
- 42" - Code: 6040T4200



Knipex Cobalt Compact Bolt Cutters

- With precision cutting edges for soft, hard and piano wire
- Cuts material like bolts, nails, rivets etc up to 5.2mm diameter
- Exceptional cutting performance with minimum effort because of new lever action design
- Cutting edges additionally induction hardened, hardness approx. 64HRC
- Forged
- Chrome vanadium electric steel, oil hardened and tempered
- 200mm

Code: 6135T7101200



Irwin Record Centre Cut Cable Cutters

- Medium duty, general purpose
- For copper and aluminium

Up to 16mm wire rope & 21mm OD armoured electric cable
Code: 3562TWC16
 Up to 26mm unarmoured copper & aluminium cable
Code: 3562TCC26





SPEAR & JACKSON

BRICKLAYING BUILDERS & CONTRACTORS

Marshalltown Brick Trowels

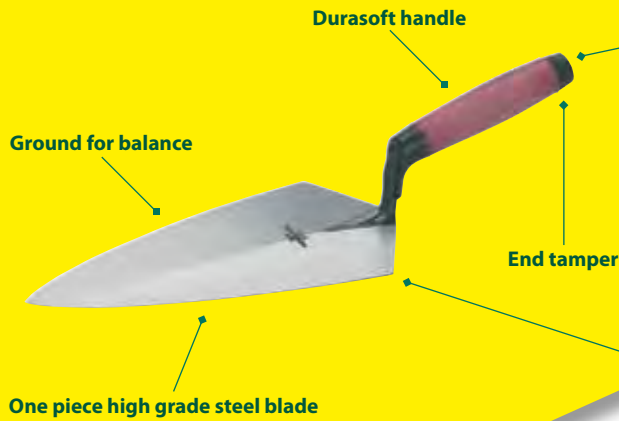

Handles also available in Wooden & Leather



Code	Size
7081TM1910D	10" Philadelphia - Durasoft
7082T1100FG	11" Philadelphia - Durasoft
7082T1200FG	12" Philadelphia - Durasoft
7082T1000	10" Philadelphia - Wooden
7082T1100W	11" Philadelphia - Wooden
7082T1200W	12" Philadelphia - Wooden
7082T1100L	11" Philadelphia - Leather
7084T1100D	11" London Pattern - Durasoft

Marshalltown Pointing Trowels

- Ground and polished
- Durasoft handle



Code	Size
7092T0500D	5" Pointing - Durasoft
7092T0600D	6" Pointing - Durasoft
7092T0500	5" Pointing - Wooden
7092T0600	6" Pointing - Wooden

Spear & Jackson Pointing Trowels

- Lighter and better balanced for easy use
- High lift for extra knuckle clearance



Code	Size
4074T0400P	4" WHS Pointing Trowel
4074T0500P	5" WHS Pointing Trowel
4074T0600P	6" WHS Pointing Trowel



Hardman 11" Philadelphia Pattern Brick Trowel

- Cross ground finish
- Light but durable in use
- Correct blade lift
- Ergonomic soft grip handle
- Fully tempered and ground balanced blade

Code: AT10020



Hardman Pointing Trowels

- Philadelphia pattern
- Innovative comfort grip
- Designed for hardwearing performance

5" - Code: AT10025

6" - Code: AT10026



Hardman 7" Gauging Trowels

- Innovative comfort grip handle
- Designed for hardwearing performance

Code: AT10030



Marshalltown Gauging Trowels

- Forged from a single piece of highest grade tool steel
- Carefully taper ground and polished
- Used for mixing of "gauging" small quantities of quick setting plaster

7" Trowel - Durasoft Handle - Code: 7093T0700D

7" Trowel - Wooden Handle - Code: 7093T0700



Spear & Jackson Gauging Trowels

- Designed for professional use
- Solid forged

6" - Code: 4075T0600G

7" - Code: 4075T0700G

8" - Code: 4075T0800G



Hardman Bucket Trowels

- Stainless steel blade
- Innovative comfort grip handle
- Rounded corners

7" - Code: AT10060



Marshalltown Brick Jointers

- Hardened blade
- Double ended for concave jointing in brickwork



Code	Size
7097T80	1/2" x 5/8" Brick Jointer
7097T81	3/4" x 7/8" Brick Jointer
7097T82	5/8" x 3/4" Brick Jointer
7097T83	3/8" x 1/2" Brick Jointer

Hardman Line Pins

- Individually forged, rust inhibiting plated finish
- Suitable for hardened mortar

Code: AT10068



Hardman Tarpaulin

- Heavy duty woven polythene (100g/m²)
- Waterproof, rot proof and UV resistant
- Rope reinforced hems
- Metal eyelets every 1 metre
- Green colour

Code: AT14970



Hardman Flat Cold Chisels

- Premium quality for general cutting of metals & stonework
- Forged from octagonal carbon steel
- Complies with BS 3066 standard



Code	Size
AT28005	1/4 x 4"
AT28007	1/4 x 6"
AT28009	3/8 x 5"
AT28010	3/8 x 6"
AT28011	1/2 x 6"
AT28013	1/2 x 8"
AT28015	3/4 x 8"
AT28016	3/4 x 10"
AT28016A	3/4 x 12"
AT28016B	3/4 x 18"
AT28017	1 x 10"
AT28018	1 x 12"
AT28018A	1 x 18"
AT28018B	1 x 24"
AT28020	10" Plugging Chisel
AT28030	10" c/w Hand Guard

Hardman Scutch Holder Chisel

- Designed for stone dressing
- Used in conjunction with scutch combs

1" / 25mm - **Code: AT28050**
 1 1/2" / 38mm - **Code: AT28051**



Hardman Brick Bolsters

- Forged from cast carbon steel
- Designed for cutting brick, stone and paving
- Hand guard for safety and comfort
- Complies with BS 3066 standard



Code	Size
AT28041	3" Bolster Chisel
AT28042	4" Bolster Chisel
AT28025	3" Bolster Chisel c/w Hand Guard
AT28026	4" Bolster Chisel c/w Hand Guard
AT28040	2 1/4" Electricians Bolster
AT28035	2 1/4" Electricians Bolster c/w Hand Guard
AT28040A	18 x 2 1/4" Electricians Chisel

Hardman Slaters Axe

- Right handed
- For trimming and punching roofing slate
- Hickory shaft

Code: AT57015



Hardman Slaters Hammer

- Hickory shaft
- Strapped to provide durability and strength

Code: AT57018



Hardman Slaters Ripper

- Solid forged
- Tapered

Code: AT57017



Hardman Pick

- Solid forged
- Rugged performance

7lb Chisel & Point Pick Head - **Code: AT48010**
 5lb Grubbing Mattock Head - **Code: AT48013**
 36" Hickory pick Handle - **Code: AT48020**



Spear & Jackson Mortar Pick

- Used by bricklayers for cleaning work and broken debris from brick and stonework prior to repointing
- Chisel and point or double point end available which are hardened for strength
- Hickory shaft

Code: 4093TSJMPHDP



Hardman Wire Scratch Brush

- Heavy duty
- Wooden handle
- Made in Germany



Code	Size
AT14959	3-Row
AT14960	4-Row
AT14961	4-Row - c/w Scraper
AT14962	4-Row - Stainless Steel

Hardman Floor Scrapers

- Heavy-duty floor scraper
- Carbon steel blade
- Blades angled for easy use in corners/edges
- Steel powder coated handle

200mm Light Duty Floor Scraper - **Code: AT57030**
 320mm Heavy Duty Floor Scraper - **Code: AT57036**
 450mm Heavy Duty Floor Scraper - **Code: AT57035**



Hardman Scraper Blades

- Heavy-duty floor scraper
- Blades angled for easy use in corners/edges

450mm - **Code: AT57037**
 320mm - **Code: AT57038**
 200mm - **Code: AT57038A**



Tubtrugs

- General purpose tubs
- Super flexible, durable, UV and frost resistant with strong CE tested handles
- Different colours & sizes available

Colours

- Blue
- Green
- Red
- Yellow

Size

Small - 14LTR
 Medium - 26LTR
 Shallow Tub - 35LTR
 Large - 40LTR
 X Large - 75LTR



Code	Size	Colour
TUB14LB	14LTR	Blue
TUB14LG	14LTR	Green
TUB14LR	14LTR	Red
TUB14LY	14LTR	Yellow
TUB26LB	26LTR	Blue
TUB26LG	26LTR	Green
TUB26LR	26LTR	Red
TUB26LY	26LTR	Yellow
TUB35LG	35LTR	Green
TUB35LY	35LTR	Yellow
TUB40LB	40LTR	Blue
TUB40LG	40LTR	Green
TUB40LR	40LTR	Red
TUB40LY	40LTR	Yellow
TUB75LG	75LTR	Green
TUB75LY	75LTR	Yellow

Builders Buckets

- Heavy duty c/w pouring lip
- 3 Gallon bucket
- Black or Yellow

Black - **Code: 8148T15LBBB**
 Yellow - **Code: 8148T15LYHD**



Campbell A-Short Link

- Round link chains
- Welded
- Electro Galvanised and Blue Chrome
- Din 5685

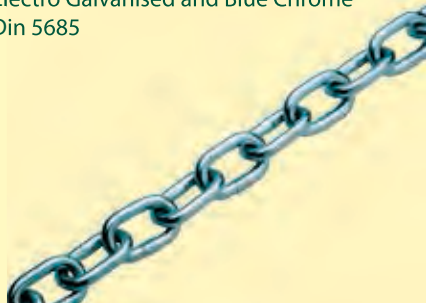

Code	Size
4795T0313027	2mm/60mtr Reel
4795T0313037	3mm/100mtr Reel
4795T0313047	4mm/50mtr Reel
4795T0313057	5mm/35mtr Reel
4795T0313067	6mm/35mtr Reel
4795T0313087	8mm/20mtr Reel

Campbell Quick Link

- Quick link
- Electro Galvanised



Code	Size
4795T0983672	5mm
4795T0983674	8mm

Campbell C Link (Long Link)

- Round link chains
- Welded
- Electro Galvanised and Blue Chrome
- Din 5685



Code	Size
4795T0332007	2mm/60mtr Reel
4795T0333007	3mm/60mtr Reel
4795T0334007	4mm/58mtr Reel
4795T0335007	5mm/32mtr Reel
4795T0336007	6mm/28mtr Reel
4795T0337007	7mm/26mtr Reel
4795T0338007	8mm/20mtr Reel



The Deb Group aspires to be the world's leading away from home skin care system company - the supplier of choice for companies and organisations that value employee and customer well-being.



Clamps/Cramps & Vices

IRWIN
Record.

Hardman
WORK TOUGH TOOLS

Irwin Record 119 'G' Clamps



Code	Size
3517T0200	2"/50mm
3517T0300	3"/75mm
3517T0400	4"/100mm
3517T0600	6"/150mm



Irwin Record 120 'G' Clamps

- For both metal and woodworking applications
- The 120 is the most popular and widely used

Code	Size	Code	Size
3518T0300	3"/75mm	3518T0800	8"/200mm
3518T0400	4"/100mm	3518T1000	10"/250mm
3518T0600	6"/150mm	3518T1200	12"/300mm

Irwin Record 121 'G' Clamps

- The strongest G clamp you can buy
- Recommended particularly for metalworking and fabrication work where a very high clamp force is demanded



Code	Size
3519T0300	3"/75mm
3519T0400	4"/100mm
3519T0600	6"/150mm
3519T0800	8"/200mm
3519T1000	10"/250mm
3519T1200	12"/300mm

Hardman 'G' Clamps

- Girder construction
- Castellated thread for robust clamping



Code	Size
AT25001	3"/75mm
AT25002	4"/100mm
AT25003	6"/150mm
AT25004	8"/200mm
AT25005	10"/250mm
AT25006	12"/300mm

Irwin Quick-Grip XP Clamp Spreaders

- Maximum gripping strength with one hand
- Full face pads
- Lockable swivel jaws
- Up to two times more clamping force than other one handed bar clamps
- Free sliding I-beam bar
- Low-explosive release mechanism
- Quick change screw no tool required



Code	Size
3526T10505942	6"/150mm
3526T10505943	12"/300mm
3526T10505944	18"/450mm
3526T10505945	24"/600mm
3526T10505946	36"/900mm
3526T10505947	50"/1250mm

Irwin Quick-Grip Bar Clamp

- Uses included clamping - holding - spreading
- Heat treated steel bar gives resistance to bending and wear
- Quick release trigger
- Jaw can be positioned anywhere on bar
- Non marking pads for a firmer grip without damaging delicate surfaces



Code	Size
3526T506QC	6"/150mm
3526T512QCTPNEW	12"/300mm
3526T518QC	18"/450mm
3526T524QC	24"/600mm
3526T536QC	36"/900mm
3526T550QC	50"/1250mm

Stanley Fatmax Auto Trigger Clamp

- Patent pending spring closure mechanism probably the fastest trigger clamp in the world
- Quick release button for speed
- Loading has now been increased to a massive 200kg (450lbs) giving ultimate clamping pressure
- Reinforced nylon and steel construction provides strength and durability
- Dual pivot trigger offers fast closing and high clamping force

6" - Code: 2500T583123
12" - Code: 2500T583124



Hardman Quick Action Clamp

- Easy to use, single-handed operation
- 150mm jaw opening capacity
- Non-marking plastic jaws will protect the workpiece
- 6" clamp

Code: AT25010



Stanley Corner Clamp - Heavy Duty

- Articulating design allows for work pieces of equal or varying thickness to be joined at right angles
- 57mm clamping capacity
- Patent-pending reversible head design allows use as a parallel clamp
- Comfort and maximum torque achieved with bi-material, tri-lobular handle
- Mounting holes allow clamp to be securely attached to work surface
- Heavy duty cast-zinc construction for durability

Code: 2500T083122



Irwin Record

122 Deep Throat 'G' Clamp

- Special heavy duty clamp with a 4"/100mm throat depth
- Used for clamping well in from the edge of work

Code: 3520T0400



Clamps/Cramps & Vices



Irwin Record Flooring Clamp

- Designed to close up floorboards prior to nailing
- For standard 3"/75mm joists

Code: 3529TMFC153



Irwin Record Corner Clamp

- Accurate mitre clamping is provided with the heavy duty M141
- Solid grey iron bodies and precision machined clamping give a positive location and easy access for gluing and nailing

4 1/4" Heavy Duty
Code: 3527T0418



Carver Heavy Duty Jaws T257

- Moveable jaw
- Safe, stable & strong
- Orange epoxy coating for durability

Code: 7774TT2572



Carver Standard Rack Clamps T186

- No long screws to bend
- Spring loaded jaw stays in position when pressure removed
- Jaw moves to securely clamp angled surfaces
- Working parts not exposed to weld spatter
- Tightening action cannot rotate workpiece

6"/150mm - **Code: 7770T0600**
 12"/300mm - **Code: 7770T1200**
 30"/750mm - **Code: 7770T3000**
 24"/600mm Long Reach - **Code: 7771T2400**



Carver Medium Duty Rack Clamp T290

- No long screws to bend
- Spring loaded jaw stays in position when pressure removed
- Jaw moves to securely clamp angled surfaces
- Working parts not exposed to weld spatter
- Tightening action cannot rotate workpiece

9"/225mm - **Code: 7772T0900**
 18"/450mm - **Code: 7772T1800**



Carver Heavy Duty Jays T257

- Safe, stable & strong
- Orange epoxy coating for durability

6" - **Code: 7774T0600J**
 12" - **Code: 7774T1200J**
 18" - **Code: 7774T1800J**
 24" - **Code: 7774T2400J**

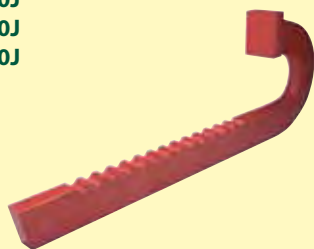

Irwin Record Cramp Heads M130

- Low cost alternative to full size bar clamps
- The grey cast iron head and slide with steel mainscrew can be fitted to a wooden batten - 1"/25mm thick by 1 1/2"/38mm wide and any length

Code: 3530TM130

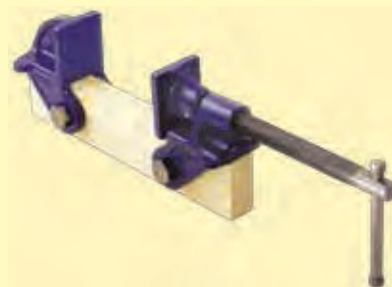

Irwin Record Sash Clamps 135

- Bar section of 32mm x 6mm
- The slide and head are guaranteed unbreakable
- Slide secured by a solid steel pin



Code	Size	Code	Size
3524T2400	24"	3524T4800	48"
3524T3000	30"	3524T5400	54"
3524T3600	36"	3524T6600	66"
3524T4200	42"	3524TL1354	36" Lengthening Bar

Irwin Record Heavy Duty T-Bar 136

- Very rigid T section steel bar
- Resists twisting and distortion under very high clamping pressures
- Head and slide are guaranteed unbreakable
- Fixed head has drilled feet for bench mounting



Code	Capacity/Size
3525T4200	42"/48" Overall
3525T4800	48"/52" Overall
3525T5400	54"/60" Overall
3525T6600	66"/72" Overall
3525T7800	78"/84" Overall
3525TL1366	48" Lengthening Bar

Hardman All Steel Engineers Vices

- Built to withstand the shocks of hammering, chipping and other tough applications
- Intergrated ANVIL and an extra heavy-duty sliding jaw and large diameter screw

4" - Code: AT84003AS
6" - Code: AT84006AS
8" - Code: AT84008AS



Irwin Record Fitters Vice

- Designed for fitting, filling and large assembly work
- This vice is standard equipment for many industrial and training workshops

No 23 - 4 1/2" - Code: 3502T0418
No 25 - 6" - Code: 3502T0600



Irwin Record Mechanic's Vice

- Top quality grey-iron castings
- Fused steel handle will bend before the vice can be over stressed
- Fully machined on all load bearing surfaces
- Safety stop prevents the slide from being seperated from the body
- Unbreakable S.G iron nut can be replaced when worn
- Batch tested on both body and slide castings



Code	Size
3500TNO1	3"/75mm
3500TNO3	4"/100mm
3500TNO4	4 1/2"/115mm
3500TNO5	5"/125mm
3500TNO6	6"/150mm
3500TNO8	8"/205mm

Stanley Maxsteel Bench Vice

- Cast-Iron construction strength and durability
- Base bolts directly to work bench for stability
- Base swivels and locks for versatility
- Roll-formed screw threads ensure smooth operation and durability
- Chrome plated to resist corrosion



Code	Size
2500T183066	4"/100mm Heavy Duty
2500T183067	5"/125mm Heavy Duty
2500T183068	6"/150mm Heavy Duty
2500T183065	4 1/2"/115mm Light Duty

Clamps/Cramps & Vices



Irwin Record Plain Screw Woodworking Vice

- Manufactured in 3 capacities
- Full size workshop vice is designed for bench mounting

52PD - 7" - Code: 3511T0700
52 1/2PD - 9" - Code: 3509T0900



Irwin Record Quick Release Woodworking Vice

- Squeeze the trigger and quick release vice can be opened and closed without using the main screw

52ED - 7" - Code: 3512T0700D
52 1/2ED - 9" - Code: 3512T0900D
53ED - 10 1/2" - Code: 3512T1018



Irwin Record Hobby Vice

- Ideal for young woodworker / home handyman
- Robust enough for the professional

V149B - 6" - Code: 3507T0600B
V150B - 6" - Portable Vice - Code: 3507T0600VB
V175B - 7" - Portable Vice - Code: 3507T0700B



Stanley Multi-Angle Hobby Vice

- The patented ball joint allows you to rotate your project a full 360° and lock it any angle
- Multiple positions for convenience and easy access
- Made of durable cast aluminium lightweight but very strong
- 3" jaw opening holds a wide range of items
- Removable rubber jaw covers wide range of application for protecting delicate finishes
- The large C-clamp mount attaches to work surfaces up to 2 3/8" thick - also suitable for heavy duty applications

Code: 2500T183069



Irwin Record Drill Press Vice 414

- Quality and precision are hallmarks of Irwin Record drill press vices
- An ideal addition to the engineering workshop or tool room

Code: 3508T0400



Hardman 10pce Elastic Strap Kit

Kit Contains

- 2pce of 4mm x 250mm
- 2pce of 8mm x 455mm
- 2pce of 8mm x 500mm
- 2pce of 8mm x 600mm
- 2pce of 8mm x 750mm

Code: AT59004



Hardman Ratchet Tie Downs

4m x 25mm 2 Claw 0.75 Tonne - Code: AT59001
4m x 35mm 2 Claw 3 Tonne - Code: AT59002
8m x 48mm 2 Claw 5 Tonne - Code: AT59003

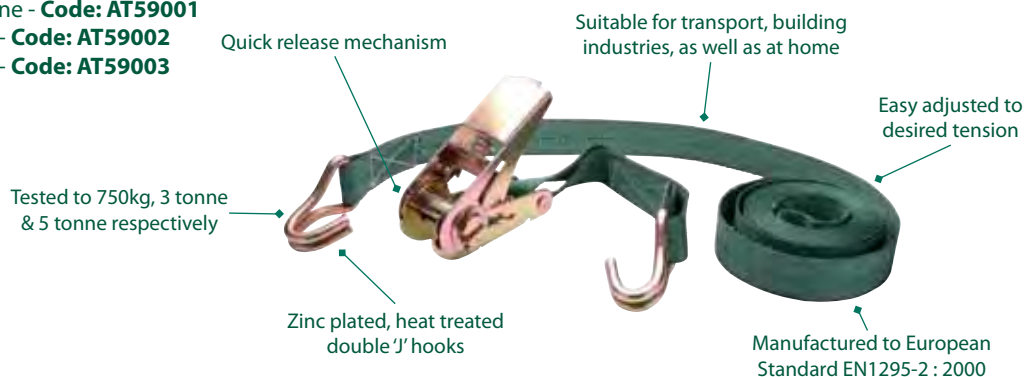



CONTRACTORS

Handle Profiles



T - Handle

Offering traditional comfort, this hardwood handle is securely morticed, tenoned and glued to a shaft of the same material



MYD All Metal

These handles are found on wood shafted tools. The galvanised steel frame is fitted with a wooden grip for comfort.



Plastic D Handle

Manufactured from high-grade polypropylene to withstand wear & tear, handle will weather the elements and will not rot or rust.

Bulldog No 2 Open Socket Square Mouth Shovel

- The ideal tool for shovelling out or backfilling trenches, concrete mixing, working tarmac and moving cement chippings

PD Handle

Code: 3701T2SM2PD

T - Handle

Code: 3701T2SM2T



Spear & Jackson

- Weather-proofed solid ash shaft secured in the socket by an aluminium rivet for maximum stability
- Suitable for concrete mixing, working tarmac, moving sand or ballast and clearing out or back filling trenches

Code: 4142T2521UA



Bulldog No2 Taper Mouth MYD Handle Shovel

- The tool choice for heavy industrial and contracting work
- The metal handle provides extra strength and wooden cross piece allows for comfort and grip
- Hot double roll formed from one single piece of best quality steel
- The solid socket is forged as integral part of the blade
- Strongest shovel available
- Tubular steel shaft

Code: 3701T5TM2AM



Bulldog No2 Taper Mouth Shovel - Hardwood Shaft

- Blade and straps are a solid one-piece manganese steel forging, riveted to an ash shaft
- Strongest shovel available
- Shaft is varnished for weather protection

MYD Handle

Code: 3701T5TM2MYD

T - Handle

Code: 3701T5TM2T



Hardman No2 Taper Mouth MYD Handle Shovel

- The tool choice for heavy industrial and contracting work
- The metal handle provides extra strength and wooden cross piece allows for comfort and grip
- Hot double roll formed from one single piece of best quality steel
- The solid socket is forged as integral part of the blade
- Strongest shovel available
- Tubular steel shaft

Code: AT56002



Bulldog No2 Square Mouth Shovel

- Solid forged square mouth shovel, used for trench work, concrete mixing, working tarmac and shovelling
- Hardwood shaft

T - Handle

Code: 3701T5SM2T

MYD Handle

Code: 3701T5SM2MYD



CONTRACTORS



Hardman No2 Square Mouth Shovel

• The tool choice for heavy industrial and contracting work

MYD Handle - **Code: AT56001**

T Handle - **Code: AT56005**



Bulldog No2 Square Mouth MYD Handle Shovel

- Solid forged square mouth shovel
- Solid socket is forged as an integral part of the blade
- Metal handle provides extra strength and wooden cross piece allows for comfort and grip
- Used for trench work, concrete mixing, working tarmac & shovelling

Code: 3701T5SM2AM

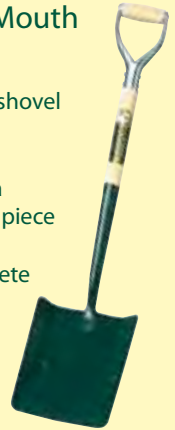

Bulldog Newcastle All Metal Draining Tool MYD Handle

- All steel solid socket construction
- Hot pressed from hot rolled heavy gauge carbon steel
- Used for digging holes, deep narrow trenches, cable channels, drain channels or post holes
- Tubular steel shaft

Code: 3701T5NDAM



Hardman All Metal Draining Tool MYD Handle

- All steel solid socket construction
- Hot pressed from hot rolled heavy gauge carbon steel
- Used for digging holes, deep narrow trenches, cable channels, drain channels or post holes
- Tubular steel shaft

Code: AT56004

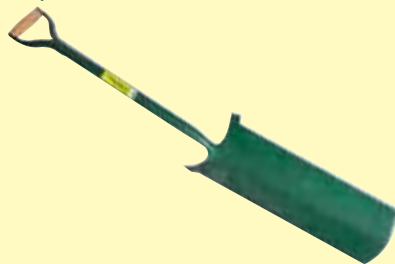

Bulldog All Metal Grafting Tool

- The slightly dished blade and round cutting edges are designed for clay digging and heavy ground breaking work
- The solid one piece blade 7 strap ensure durability
- MYD handle
- Tubular steel shaft

Code: 3701T5GTAM



Bulldog All Metal Trenching Spade

- MYD handle
- Tubular steel shaft
- Ideal for digging trenches with flattish and tapered blade

Code: 3701T5TSAM



Bulldog Square Mouth Shovel Strapped

- The strongest shovel available
- Varnished shaft for weather protection
- Solid one-piece manganese steel forging, riveted to an ash shaft

28" - **Code: 3700T4202032810**
36" - **Code: 3700T4202033610**



Hardman Pavious Mauls

- Rubber head
- Ideal for laying paving stones
- Cylindrical head approximately 300mm long x 130mm in diameter
- Handle length is 36"

Code: AT20040

Head only - **Code: AT20039**

Shaft only - **Code: AT20041**





CONTRACTORS

Bulldog All Metal No2 Round Mouth Shovel

- Used for digging, excavating and shovelling grain, sand, earth and other loose materials where the pointed blade gives ease of penetration
- T - Handle - Hardwood shaft



Code: 3701T5RM2T

Bulldog All Metal No2 Round Mouth Shovel

- Used for digging, excavating and shovelling grain, sand, earth and other loose materials where the pointed blade gives ease of penetration
- MYD handle - Tubular steel shaft



Code: 3701T5RM2AM

Bulldog All Metal Cable Laying Shovel

- Solid forged cable laying shovel
- The slightly dished blade and round cutting edges are designed for clay digging, also excellent for heavy ground breaking work



Code: 3701T5CLAM

Bulldog All Metal Trench Fork

- Bulldog attention to detail and strength but aimed at Budget conscious contractor



Code: 3701T5TFAM

Hardman Household Shovel

- 7" wood handle



Code: AT57001

Bulldog Post Driver

- Tubular steel rammer for driving posts into heavy ground, for use with round or square posts. Double handle with solid metal end plug



Code: 3700TPD1

Hardman Post Hole Digger

- Fibreglass shaft
- The reinforced shank means improved durability

Code: AT57005A



Hardman Earth Rammer

- For compacting tarmac or earth

Wood Shaft - Code: AT57006
Metal Shaft - Code: AT57007



Hardman Rakes

- Tubular steel or wooden shaft
- The reinforced shank means improved durability
- Tarmac rake has **round tines**
- Asphalt rake has **flat tines**

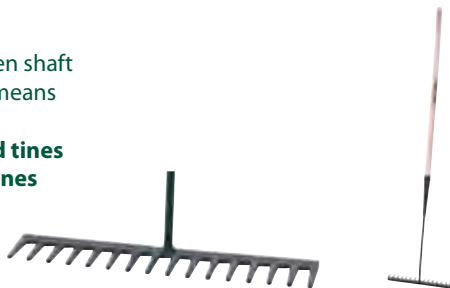

Code

Size

AT57009	Asphalt Rakes - Wood Shaft
AT57010	Asphalt Rakes - Metal Shaft
AT57011	Tarmac Rakes - Wood Shaft
AT57012	Tarmac Rakes - Metal Shaft

Hardman Rubble Sacks

- 510mm x 760mm depth (74.6gram/pc)
- Max Capacity 25kg
- Rolls of 10

Code: AT89000A



Stanley Wonder Bars

- Heat treated, forged high carbon steel for increased durability
- High visibility powder coated finish
- Contoured bar makes pulling nails, prying and lifting easier
- Polished tips and bevelled nail slots excellent for pulling nails, lifting or prying

180mm/7" - Code: 2500T155045
340mm/14" - Code: 2500T155515
530mm/21" - Code: 2500T155526



CONTRACTORS



Hardman Crowbar

- Solid forged
- Chisel and point
- Hardened and tempered

48" x 1" - Code: **AT57020**
 60" x 1 1/8" - Code: **AT57021**
 72" x 1 1/4" - Code: **AT57022**



Hardman Wrecking Bar

- Heavy duty
- Solid forged
- Built to offer rugged performance

18" x 5/8" - Code: **AT48001**
 24" x 3/4" - Code: **AT48002**
 30" x 3/4" - Code: **AT48003**
 36" x 3/4" - Code: **AT48004**



Hardman Brute Bar

- Wider chisel blade offers increased anchorage and strength
- Heat treated, forged steel for a more robust, durable bar

3 Piece Set - Code: **AT49000**
 14" - Code: **AT49001**
 24" - Code: **AT49002**
 36" - Code: **AT49003**



Cardoc Wagon Rope

- Polypropylene film with looped end, ideal for securing items quickly and effectively
- 10mm x 27mtr

Code: **6560TWR27**



Cardoc Blue Film Rope

- Multi purpose blue polypropelene rope



Code	Size
6560TCBPFR6220	6mm x 220mtr
6560TCBPFR630	6mm x 30mtr
6560TCBPFR8220	8mm x 220mtr
6560TCBPFR820	8mm x 20mtr
6560TCBPFR10220	10mm x 220mtr
6560TCBPFR1015	10mm x 15mtr
6560TCBPFR12220	12mm x 220mtr
6560TCBPFR1210	12mm x 10mtr
6560TCBPFR	16mm x 220mtr

Cardoc Blue Film Rope Plastic Reel

- Multi purpose blue polypropelene rope in plastic reels



Code	Size
6560TPRPFR6200	6mm x 200mtr
6560TPRPFR890	8mm x 90mtr
6560TPRPFR1070	10mm x 70mtr
6560TPRPFR1250	12mm x 50mtr



evolution[®]

For our evolution range

Please call for details.



CONTRACTORS

Rocol Easyline Edge Aerosol Paint

- Traffic-grade epoxy paint lasts at least twice as long as the nearest competitor
- Non-irritant formula
- Not harmful to the environment
- Not harmful to the aquatic life
- Touch dry in 10 minutes, easy to apply, no mess, no wastage
- Clog-free formulation
- Super tough 18 Bar rated aerosol cans minimise risk of puncture or failure in high temperatures
- Tested using internationally recognised test ASTM D4060-95 using a Taber Abraser



750ml Can - White - Code: **7476T47000**
 750ml Can - Yellow - Code: **7476T47001**
 750ml Can - Black - Code: **7476T47006**



Rocol Contractor Semi-Permanent Spot Marking Paint

- One pass system gives excellent visibility with 3-6 months durability
- Colour coded range for cable, water, gas and electricity company use
- Fast drying - touch dry in 5 minutes
- Clog-free formulation and twin nozzle system for added reliability
- Super tough 18 Bar rated aerosol cans minimise risk of puncture or failure in high temperatures



750ml Can - White - Code: **7476T43080**
 750ml Can - Yellow - Code: **7476T43081**
 750ml Can - Red - Code: **7476T43083**

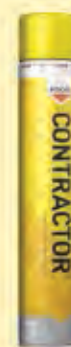

Everbuild Surveyline (700ml)

- A spray applied marking paint for contractors/surveyors spot marking
- Colour coded for electric, gas, water and cable company use
- Semi permanent formula lasts at least 3 months after application

Code	Description
3017TSURVEYWHT	General Marking (White)
3017TSURVEYYEL	General Marking (Yellow)
3017TSURVEYBLU	Water (Blue)
3017TSURVEYRED	Electricity (Red)
3017TSURVEYGRN	Cables (Green)
3017TSURVEYBK	Deletes Existing Markings (Black)
3017TSURVEYORG	General Marker (Orange)



Everbuild Surveyline Applicator

- Unique hand held applicator for use with Surveyline and most other marking aerosols
- Canister simply clicks into place, prevents finger strain and speeds up application

Code: **3017TSURVEYAPP**



Everbuild Trafficline (700ml)

- A spray applied marking paint for permanent line marking
- Heavy duty latex formulation for use over concrete, asphalt and most other surfaces
- Ideal for car parks, warehouses, tennis courts, playgrounds etc. Trafficable in 1 hour at normal temperatures

Code	Description
3017TTRAFFICWHT	General Marking (White)
3017TTRAFFICYEL	Caution Hazard (Yellow)
3017TTRAFFICRED	Danger/Prohibited (Red)



Everbuild Trafficline Applicator

- Sturdy 4 wheel line marking applicator for use with Trafficline and Turfline aerosols

Code: **3017TTRAFFICWHEEL**



COUNTERSINKS & HINGE BORING BITS

Vitrex

- 13mm x 90 DEG
- Medium Duty

Code: 4603T400595

- 13mm x 90 DEG
- Heavy Duty

Code: 4603T401450



Spear & Jackson Hinge Boring Bits

- Designed to accurately bore holes for concealed hinges

- **1235** - Carbon Steel - Suitable for boring soft and hard boards

35mm - **Code: 4138T707**

- **1335** - Tungsten Carbide Tipped - Suitable for boring man made boards

35mm - **Code: 4138T707T**



Disston Screw Digger

- The countersinking part can be slid up and down the drill part of the tool
- Ideal for drilling, countersinking and counterboring in one operation
- Screwdigger can be adjusted to predrill for different lengths of screw

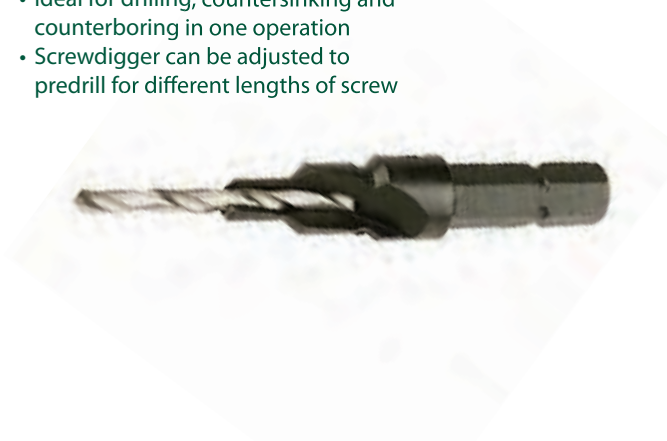

Code

Size

4661T49	No6 - Uses 3/32" Drill Bit
4661T54	No8 - Uses 7/64" Drill
4661T56	No10 - Uses 1/8" Drill Bit
4661T58	No12 - Uses 9/64" Drill Bit
4661TSET	4Pce Screw Digger Set 6 8 10 & 12G

Disston Plug Cutters

- For cutting wood plugs to cover recessed screw holes to achieve a neat finish
- For a perfect grain match use an offcut from the timber being plugged
- To ensure an accurate fit, use the same screwdigger from the disston brand



Code

Size

4661T5594	Plug Cutter Fits No.6 Only
4661T5595	Plug Cutter Fits No.8 Only
4661T5596	Plug Cutter Fits No.10 Only
4661T5597	Plug Cutter Fits No.12 Only

Stanley Hobby Paint Brushes

- Budget quality black bristle paint brush ideal for general DIY decorating tasks
- Can be used with all types of paint

12mm - Code: **2896T018**
 25mm - Code: **2896T100**
 38mm - Code: **2896T118**
 50mm - Code: **2896T200**
 63mm - Code: **2896T218**
 73mm - Code: **2896T429556**
 100mm - Code: **2896T429557**
 5pc Hobby Set - Code: **2896TSETS**



Stanley Decor Paint Brushes

- Medium quality black bristle paint brush for use with all emulsion and acrylic paints

12mm - Code: **2896T426274**
 19mm - Code: **2896T426275**
 25mm - Code: **2896T429351**
 38mm - Code: **2896T429352**
 50mm - Code: **2896T429353**
 63mm - Code: **2896T429354**
 75mm - Code: **2896T429355**
 100mm - Code: **2896T400**
 5pc Hobby Set - Code: **2896T026727**



Stanley Dynagrip Max Finish Stripping Knives

- Suitable for stripping paint & wallpaper
- Fully ground stainless steel blade
- Comfortable handle resistant to normal paint solvents

25mm - Code: **2896T028650**
 50mm - Code: **2896T028651**
 75mm - Code: **2896T028652**
 100mm - Code: **2896T028653**



Stanley Long Handled Scraper

- Suitable for heavy duty removal of paint and adhesives
- Angled head enables additional pressure to be applied
- Replaceable carbide steel blades

100mm - Code: **2896T028004**
 Spare Blades - Code: **2896T028005**



Stanley Razor Edge Scraper

- Retractable blade razor blade scraper with five single edge blades

Code: **2896T028500**



Stanley Radiator Roller

- 100mm - suitable for decorating behind radiators and awkward places
- Supplied with two synthetic pile rollers

100mm - Code: **2896T25**



Stanley Roller Kit

- Contains plastic tray, 1 roller head and handle
- Medium pile synthetic roller for applying emulsion paint

175mm - Code: **2896T700**
 225mm - Code: **2896T900**

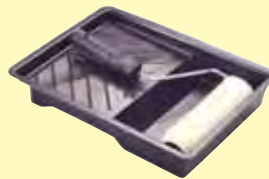

Stanley Mini Roller Kit

- Contains plastic tray, 2 roller heads and handle
- Fabric roller head for applying emulsion paint
- Foam roller head for applying gloss paint

100mm - Code: **2896T429480**



Stanley Roller Refills

- Replacement sleeves for the Stanley range of decorating rollers

9" Medium Pile - Code: **2896T429489**
 9" x 1 3/4 Long Pile - Code: **2896T429487**
 7" Medium Synthetic - Code: **2896T429863**
 9" Medium Synthetic - Code: **2896T429864**



Builders Tarpaulin

- 12ft x 18ft
- Heavy Duty reusable waterproof sheets
- Ideal temporary cover with many uses in the home and garden

Code: **2896T129694**



Hardman Tarpaulin

- 3.5mtr x 5.4mtr
- Heavy Duty, waterproof sheets, rot proof & UV resistant
- Rope reinforced hems

Code: **AT14970**



Dust Sheet - Cotton Twill

- 12ft x 9ft
- Durable heavy-duty dust sheets - 100% Cotton Twill
- Washable and reusable

Code: **2896T129689**



Hardman Dust Sheet

- 12ft x 9ft
- Cotton twill

Code: **AT14970**



DECORATING SUNDRIES

Barrettine

Barrettine White Spirit

- Petroleum solvent, ideal as a thinner for paints due to its high solvency powers, quick drying properties and lack of greasiness

2L - Code: 7026TWH5B2000
750ml - Code: 7026TWH5B0750



Barrettine Creocote

- Traditional Creocote

4L Dark - Code: 7026TCRC0D04D
4L Light - Code: 7026TCRC0D04L



Barrettine Methylated Spirits

- For thinning French Polish, cleaning brushes after knotting, cleaning glassware etc.
- Can be used as a fuel in certain lamps, check instructions before use

500ml - Code: 7026TMMSP0500



Barrettine Turps Substitute

- A cheaper solvent used as a general purpose cleaning solvent and also as a paint thinner where quick drying is of less importance

2L - Code: 7026TTUSU2000



Drain & Toilet Cleaner

- Sulphuric acid based product (with inhibitor) specially designed to rapidly clear blockages in drains pipes and toilets
- Industrial strength for trade and professional use

1L - Code: 7026TKOAK1000
500ml - Code: 7026TKOKB0500



Pathway & Patio Cleaner

- Acid based cleaner, removes grime, dirt, leaf stains and is suitable for cleaning brick work

4L - Code: 7026TPCAK4000



Caustic Soda

- Strips paint, cleans wood and clears blocked drains

500g - Code: 7026TCASO05006



Paint Remover / Stripper

- A traditional product that will remove most paints, varnishes etc.

1L - Code: 7026TSTPS1000



Kitchen & Bathroom Cleaner

- A sodium hydroxide solution specially designed to clear fat, grease and hair in kitchen sinks, baths & showers

500ml - Code: 7026TKOKB0500



MSM Wiping Cloths

- Rags for everyday use

White Lint Free Wiping Cloth - Code: 7680TLINT
Economy Wiping Cloth (Sweat Shirt) - Code: 7680TSWEAT
General Purpose Wiping Cloth (Towelling) - Code: 7680TTOWEL



Stanley Intellisensor Pro Metal Stud Sensor

Code: 2500T077355



Stanley Metal Sensor

- Locates the edge of metal studs including iron, rebar and non-ferrous metal such as copper
- Locates live electrical wires to 50mm depth
- Depth detection to 75mm
- One button calibration
- Backlit LCD display indicating the edge of the metal using a bar graph
- Audible and visible indicator
- Powered by 9v battery (not supplied)

Code: 2500T077445



Stanley Intellisensor

- Locates the edges of metal (ferrous) and wooden studs and joists (**does not** differentiate between wood and metal)
- Depth detection to 19mm
- One button calibration
- 4 LED display indicating the edges of the stud
- Audible and visible indicator
- Powered by 9v battery (not supplied)

Code: 2510T077100



Stanley Intellisensor Pro Stud Sensor

- Locates the edges of metal (ferrous) and wooden studs and joists (**does not** differentiate between wood and metal)
- Locates live electrical wires to 50mm depth
- Depth detection of 12mm/25mm/38mm
- One button calibration
- Backlit LCD display indicating the edges of the stud
- Audible and visible indicator
- Laser beam with vials for levelling
- Separate laser pod (included)
- Allows a laser cross line to be set
- Powered by 9v battery (not supplied)

Code: 2510T077260



Stanley Moisture Detector

- Provides moisture readings in wood and masonry
- Measures moisture in masonry from 0.2-2% (readings over 1.5% are suspicious and need investigating)
- Measures moisture in wood from 6-44% (readings over 15% are suspicious and need investigating, over 20% indicate decay)
- Two detection pins (8mm length) to locate in material being tested
- Backlit LCD display indicating the moisture level on a bar graph
- Powered by 3 cell batteries (supplied)
- Auto power off

Code: 2510T077030



Stanley Stud Sensor 200

- Locates the centre of metal (ferrous) and wooden studs and joists (**does not** differentiate between wood and metal)
- Locates live electrical wires to 50mm depth
- Depth detection to 19mm
- One button calibration
- Backlit LCD display indicating the centre of the stud
- Audible and visible indicator
- Powered by 9v battery (not supplied)

Code: 2500T077720



Stanley Intellisensor Plus

- Locates the edges of metal (ferrous) and wooden studs and joists (**does not** differentiate between wood and metal)
- Depth detection to 12mm/19mm/25mm
- One button calibration
- 4 LED display indicating the edges of the stud
- Audible and visible indicator
- Powered by 9v battery (not supplied)

Code: 2510T077115



DETECTORS

ZIRCON®

Zircon Studsensor Edge

- Finds the edge of wood or metal studs up to 19mm deep
- An updated arrow-shaped spotlight pointer and audio tone clearly indicate stud edges

Code: 7080TZ63739



Zircon Studsensor Edge E30

- Finds the edge of wood or metal studs up to 19mm deep
- An updated arrow-shaped spotlight pointer and audio tone clearly indicate stud edges
- Wire warning detection indicates the presence of live electrical wiring

Code: 7080TZ63987



Zircon Studsensor Edge E40

- Finds the edge of wood or metal studs or joists up to 38mm deep
- An updated arrow-shaped spotlight pointer and audio tone clearly indicate stud edges
- Wire warning detection indicates the presence of live electrical wiring

Code: 7080TZ63964



Zircon Studsensor Edge E50

- Finds the edge of wood or metal studs or joists up to 38mm deep
- An updated arrow-shaped spotlight pointer and audio tone clearly indicate stud edges
- Wire warning detection indicates the presence of live electrical wiring

Code: 7080TZ63969



Zircon Studsensor SL Edge Finder

- Finds the edge of wood or metal studs or joists up to 19mm deep
- Spotlight pointing system and audio tone clearly indicate stud edges

Code: 7080TZ62138



Zircon Studsensor Pro SL Edge Finder

- Finds the edge of wood or metal studs or joists up to 38mm deep
- Spotlight pointing system and audio tone clearly indicate stud edges

Code: 7080TZ62135



Zircon Studsensor Pro LCD Finder

- Finds the edge of wood or metal studs or joists up to 38mm deep
- The easy to read LCD screen, spotlight pointing system and audio tone clearly indicate stud edges
- Wire warning detection indicates the presence of live electrical wiring

Code: 7080TZ62147



Zircon Multiscanner Pro SL Edge Finder

- Finds the edge of wood or metal studs or joists up to 38mm deep
- Locates metal pipes or rebar up to 76mm deep and live electrical wires up to 51mm deep
- Easy to read LCD screen

Code: 7080TZ62120



Zircon Studsensor i65 One Step Centre Finder

- Finds the centre and edges of wood or metal studs or joists up to 38mm deep
- The easy to read LCD screen indicates direction, edge and centre of the studs
- Wire warning detection indicates the presence of live electrical wiring

Code: 7080TZ62128



Zircon Multiscan i500 One Step Wall Scanner

- Finds the centre and edges of wood or metal studs or joists up to 38mm deep
- Locates metal pipes or rebar up to 6mm deep and live electrical wires up to 51mm deep
- ACT Auto Correcting Technology corrects common user errors automatically
- Ultra-bright LCD screen

Code: 7080TZ62116



Zircon Multiscan i520 One Step Centre

- Finds the centre and edges of wood or metal studs or joists up to 38mm deep
- Locates metal pipes or rebar up to 76mm deep and live electrical wires up to 51mm deep
- ACT Auto Correcting Technology corrects common user errors automatically
- Ultra-bright LCD screen

Code: 7080TZ62291



Zircon MetalliScanner m40

- Finds metal up to 10cm deep through solid concrete and most non-metallic surfaces
- Wide and pinpoint scanning positions find metal in walls, floors and ceilings
- Scan reclaimed lumber for hidden metal before sawing or planing
- Find studs in lath and plaster walls by locating the row of nails
- Ideal for DIY use

Code: 7080TZ62616



Zircon MetalliScanner MT6 Heavy Duty

- Finds metal up to 15cm deep through solid concrete and most non-metallic surfaces
- The easy to read LCD screen indicates target location, depth and type of metal (ferrous or non-ferrous)
- Scan concrete before drilling or sawing to locate rebar and find plumbing or ductwork inside walls
- Ideal for heavy duty use

Code: 7080TZ62151



Zircon ElectiScanner v5 Wire Locator

- Pinpoint live wires, behind the wall, with no contact necessary
- Zircon's ElectiScanner v5 uses dynamic calibration, constantly re-adjusting and self-correcting to find the strongest electrical signal in the area
- Locates live AC wires up to 440v
- Two scanning modes and directional indication give users the best search results possible
- Complete with hard 'Attache' style case for protection

Code: 7080TZ64223



Locking Pliers

Full range available from page 77



DIAMOND BLADES



Hardman VFM Diamond Blade Range

- Conventional segment design
- Key-hole gullets, high tensile steel core
- Strong performance in all UK aggregate concretes
- Suitable for use on medium reinforced concrete

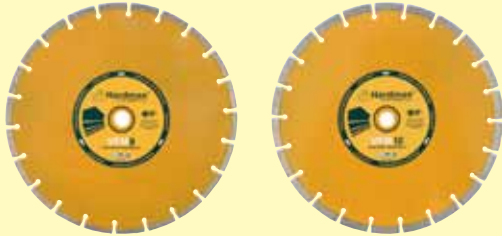

Code	Size	VFM Range
AT70005	115mm x 22mm	VFM 8
AT70006	125mm x 22mm	VFM 8
AT70007	230mm x 22mm	VFM 8
AT70008	300mm x 20mm	VFM 8
AT70025	115mm x 22mm	VFM 10
AT70027	230mm x 22mm	VFM 10
AT70028	300mm x 20mm	VFM 10

VFM 8 Denotes 8mm Sintered Segment
VFM 10 Denotes 10mm Sintered Segment

Hardman Multicut

- 15mm segment height (300mm & 230mm)
- 12mm segment height (115mm)
- Turbo segment design for faster, cooler cutting and clearing waste material faster
- Suitable on heavily reinforced concrete, ideal as construction site blade

115mm x 22mm - **Code: AT70015**
230mm x 22mm - **Code: AT70017**
300mm x 20mm - **Code: AT70018**



Hardman Mortar Rake Blade

- 6mm thick segment height
- Suitable for all mortar types
- Providing good speed of cut & life

115mm x 6mm x 22.2mm - **Code: AT70071**



Hardman Multi Purpose Saw Blade

The versatile saw blade specifically designed for angle grinders. Cuts through wood, plastics, PVC, MDF, fibreglass, plasterboard and much more.

- Quick clean cutting action
- Blade can be resharpened
- Not for use on metal or stone
- Run at 80m/s 12200rpm

115mm - **Code: AT70100**



Hardman 5 Piece Sintered Dry Core Kit

- Comprehensive dry diamond core drill kit
- 5 common size of core drill: (42mm, 52mm, 65mm, 117mm & 127mm)
- Comes with Chuck and SDS Adaptors, Universal Extension, Drift Key & Masonry Bit
- Aluminium carry case with preformed foam inserts
- 8mm tall segments
- Slotted barrels to aid waste clearance & cooling
- Suitable for Medium Hard bricks and soft blocks

Code: AT66008



Hardman Diamond Dry Core Drill

- Professional quality dry diamond core drills
- All popular sizes available
- Laser welded segments
- 7mm segment height



Code	Size	Description
AT65001	22mm x 400mm	1/2" BSP (F)
AT65005	28mm x 400mm	1/2" BSP (F)
AT65010	38mm x 165mm	1/2" BSP (F)
AT65015	48mm x 165mm	1/2" BSP (F)
AT65020	52mm x 165mm	1/2" BSP (F)
AT65025	65mm x 165mm	1/2" BSP (F)
AT65027	78mm x 165mm	1/2" BSP (F)
AT65030	107mm x 165mm	1/2" BSP (F)
AT65035	117mm x 165mm	1/2" BSP (F)
AT65040	127mm x 165mm	1/2" BSP (F)
AT65045	152mm x 165mm	1/2" BSP (F)

Hardman Drift Key

- Drift Key for A Taper Drills

Code: AT65070



Hardman 3 Jaw Chuck Adaptor

- 3 Jaw Chuck - 1/2" BSP (M) A Taper Adaptor

Code: AT65051



Hardman 200mm Extension Rod

- 200mm 1/2" BSP (F) - 1/2" BSP (M) Ext Rod

Code: AT65061



Hardman SDS Adaptor

- SDS - 1/2" BSP (M) A Taper Adaptor

Code: AT65052



Hardman Pilot Drill

- 200mm Pilot Drill - A Taper - Code: AT65065
- 225mm Pilot Drill - A Taper - Code: AT65066



Hardman Diamond Laser Welded Core Kits

- Quality durable & high quality storage case
- Foam insert for added protection & organisation
- Choice of core kits available



Code	Description
AT66002	38, 52 & 117mm Core Drills c/w 3 Jaw Chuck, 200mm Pilot & 5m Tape
AT66004	38, 52, 65, 117 & 127mm Core Drills c/w 3 Jaw Chuck, SDS Adaptor, 200mm Ext Rod, 200mm Pilot Drill, Drift Key & 5m Tape inside foam filled Toolbox

DRYWALL RANGE

Stanley Taping Knives

- 8"/203mm - Code: 2500TSTHT005895
- 10"/254mm - Code: 2500TSTHT005771
- 12"/305mm - Code: 2500TSTHT005776



Stanley Wall Boards Carrier

- Makes carrying drywall and other boards easier
- Sold in pairs
- Bi-material handle for comfort and protection

Code: 2500TSTHT105868



Stanley Panel Carrier

- One person can carry large flat materials with better balance and control
- Durable plastic 355mm/14" handle for extra reach
- Handle angled to keep knuckles away from panels for comfort

Code: 2500T193301



Stanley Drywall T Square - Metric

- Easy to read black markings in millimeters
- Notched head for cutting a 1220mm/4" board in one sweep
- 50mm/2" blade to cut both sides of an outlet box without moving the square
- Durable blade springs straight no matter how you flex it

Code: 2500TSTHT105894



Stanley Drywall Stripper

- Adjustable cutting depth
- Replacement blades available
- 2 cutting blades allow the end user to cut both sides of material at once
- Bi-material handle for comfort and protection

Code: 2500TSTHT116069



Stanley Circle Cutter

- Precision calibrated for accuracy
- Cuts clean holes from 25mm/1"
- - 400mm/16" diameter
- Pin adjust up and down
- Easy slide adjustment with easy to read measurements

Code: 2500TSTHT105878



Stanley Corner Bead Clincher

- Sets corner beads with one blow
- No nails or screws needed

Code: 2500TSTHT116132



Stanley Telescopic Support

- Heavy-duty ribbed aluminium body for strength and rigidity
- Adjustable pole from 1140mm - 2895mm (45" - 114")
- Efficient clamp holds panels firmly in place

Code: 2500TSTHT105932



Stanley Stud Crimper

- Ensures metal profiles are attached permanently in U - shape
- Solid steel build

- Stud Crimper (1.0mm) - **Code: 2500T15261**
- Stud Crimper 11"/279mm(0.6mm) - **Code: 2500T15273**



Stanley Stud Crimping Tool

- Ensures profiles are attached permanently
- Solid steel build

Code: 2500T169100



Stanley Drywall Screw Accessories

- Designed to sink screws to the required depth in drywall panels
- Fits any 10mm (1/2") Or 8mm 3/8") drill

- PH2 Phillips Drywall Screw Adaptor - **Code: 2500TSTHT016137**
- Drywall Spring Loaded Bit Holder - **Code: 2500TSTHT005926**



Stanley Plastic Mud Pan

- Tapered design for easy grip
- Durable and easy to clean plastic
- 10"

Code: 2500TSTHT005866



Stanley Stainless Steel Mud Pan

- Tapered design for easy grip
- Durable and easy to clean stainless steel
- 10"

Code: 2500TSTHT005867



Stanley Joint Knives

- Smooth zinc alloy handle cap for durability
- Tapered blade from handle to tip provides a smooth, even finish
- Stainless steel blade prevents rusting and provides durability
- Bi-material handle for comfort and protection
- Hole in handle for easy storage
- Also available with a PH2 Phillips bit included on cap

- Joint Knife 4"/101mm - **Code: 2500TSTHT005786**
- Joint Knife 5"/127mm - **Code: 2500TSTHT005799**
- Joint Knife 6"/152mm - **Code: 2500TSTHT005864**
- Joint Knife 4"/101mm With PH2 Phillips Bit - **Code: 2500TSTHT028000**
- Joint Knife 5"/127mm With PH2 Phillips Bit - **Code: 2500TSTHT028034**
- Joint Knife 6"/152mm With PH2 Phillips Bit - **Code: 2500TSTHT028041**



Stanley Pre-Shaped Joint Knife

- Smooth zinc alloy handle cap for durability
- Tapered blade from handle to tip provides a smooth, even finish
- Stainless steel blade prevents rusting and provides durability
- Bi-material handle for comfort and protection
- Hole in handle for easy storage

Code: 2500TSTHT026088



Stanley Clipped Joint Knife

- Smooth zinc alloy handle cap for durability
- Tapered blade from handle to tip provides a smooth, even finish
- Stainless steel blade prevents rusting and provides durability
- Bi-material handle for comfort and protection
- Hole in handle for easy storage

Code: 2500TSTHT026089



DRYWALL RANGE

STANLEY

Stanley Compound Mixers

- Perfect for mixing compound, paint and other materials
- Mixer has wings and a protective extension so they do not come in contact with the bucket
- Available in 3 sizes

80mm Diameter - **Code: 2500TSTHT228042**

100mm Diameter - **Code: 2500TSTHT228043**

120mm Diameter - **Code: 2500TSTHT228044**



Stanley Inside Corner Tool

- Tapered blade from handle to tip provides a smooth, even finish
- Stainless steel blade prevents rusting and provides durability
- Bi-material handle for comfort and protection
- Hole in handle for easy storage

Code: 2500TSTHT005777



Stanley Outside Corner Tool

- Tapered blade from handle to tip provides a smooth, even finish
- Stainless steel blade prevents rusting and provides durability
- Bi-material handle for comfort and protection
- Hole in handle for easy storage

Code: 2500TSTHT005622



Stanley Margin/Edging Trowel

- Tapered blade from handle to tip provides a smooth, even finish
- Three piece set also available
- Bi-material handle for comfort and protection
- Hole in handle for easy storage

Single Trowel

3 1/4" x 4" (82mm x 101mm)

Code: 2500TSTHT005897

3 Pce Set

- 2" x 5" (51mm x 127mm)

- 1 1/2" x 5" (38mm x 127mm)

- 3 1/4" x 4 1/4" (82mm x 108mm)

Code: 2500TSTHT005896



Stanley Finishing Trowels

- STHT0-05900 has slight bow in blade to allow user to make perfect drywall joints
- Strong, lightweight mounting for ease of use & durability
- Bi-material handle for comfort and protection

• Trowel 280mm x 130mm (11" x 5") Curved Corners - **Code: 2500TSTHT005898**

• Trowel 320mm x 130mm (12 1/2" x 5") Curved Corners - **Code: 2500TSTHT005899**

• Finishing Trowel 320mm x 130mm (12 1/2" x 5") - **Code: 2500TSTHT005900**



Stanley Hand Sander With Improved Clip

- Heavy-duty ribbed aluminium body stays flat and rigid
- Efficient clamp design to hold paper or screen firmly in place
- Sander 230mm x 80.4mm (9" x 3 1/4") accepts most sandpaper and sanding screens
- Bi-material handle for comfort and protection

Hand Sander With Improved Clip - **Code: 2500TSTHT005927**

Sanding Screen K80 x 10 - **Code: 2500TSTHT005929**

Sanding Screen K120 x 10 - **Code: 2500TSTHT005930**

Sanding Screen K120 x 100 - **Code: 2500TSTHT005931**



Stanley Aluminium Pole Utility Sander

- Heavy-duty ribbed aluminium body stays flat and rigid
- Efficient clamp design to hold paper or screen firmly in place
- 1300mm/51" Anodized aluminium handle with cushion grip for comfort
- Sander 230mm x 80.4mm (9" x 3 1/4")
- Accepts most sandpaper and sanding screens

Aluminium Pole Utility Sander - **Code: 2500TSTHT005928**

Sanding Screen K80 x 10 - **Code: 2500TSTHT005929**

Sanding Screen K120 x 10 - **Code: 2500TSTHT005930**

Sanding Screen K120 x 100 - **Code: 2500TSTHT005931**



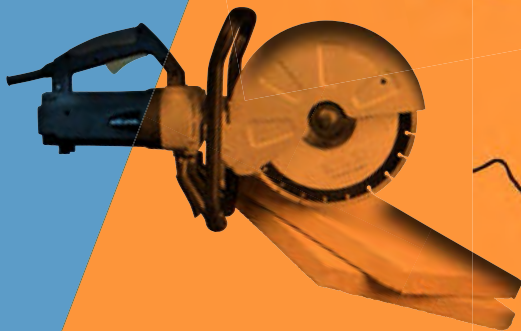

evolution[®]

Evolution has established a solid reputation over the past 20 years and is recognised worldwide as a market leader within the steel and fabrication industry.

ELECTRICAL EQUIPMENT

Hardman Triple Socket Cable Reels

25mtr/240v/13amp - **Code: AT42036**
 50mtr/240v/13amp - **Code: AT42038**

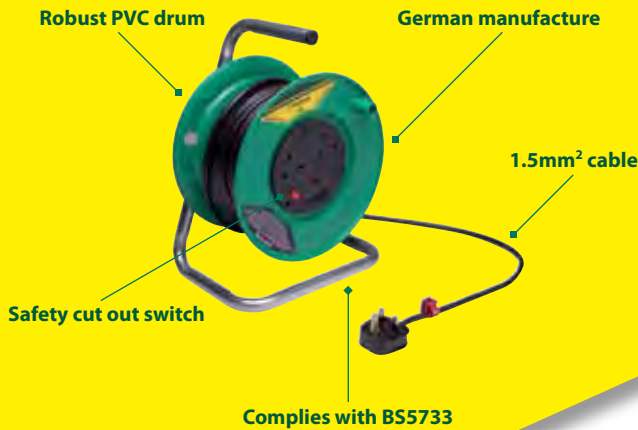

Brennenstuhl Cassette Reels

- Housing made of break-resistant plastic
- Practical carrying handle
- Twin feet ensure excellent stability
- Easy to wind and rewind
- With triple socket 240v

10mtr/240v
Code: 7201T1108563

15mtr/240v
Code: 7201T1108903



Hardman Cassette Reels

- Complete with thermal overload cut out
- Twin or Triple socket
- Robust PVC case

9mtr/110v/16amp - **Code: AT42015**



Hardman Twin Socket Cable Reels

- Complies with BS5733
- 1.5mm² cable
- Safety cut out switch
- German manufacture
- Robust PVC drum

25mtr/110v/16amp
Code: AT42035

50mtr/110v/16amp
Code: AT42037



Brennenstuhl Garant Cable Reels

- Top in quality and design for every requirement and use
- Reel body made of special break-resistant Breflex rubber
- With twin socket 110v/16a
- With new cable guide handle for precision cable management when winding and unwinding
- 1.5mm thick cable

25mtr/110v/16amp
Code: 7201T1148773

50mtr/110v/16amp
Code: 7201T1138873



Brennenstuhl Garant Cable Reels

- Top in quality and design, for every requirement and use
- Reel body made of special break-resistant Breflex Plastic
- With triple socket outlet 240v with self-closing cover providing protection against dust and contamination
- With new cable guide handle for precision cable management when winding and unwinding
- 1.5mm thick cable

Code	Size
7201T1218053	25mtr/240v/13a
7201T1208063	50mtr/240v/13a
7201T1208853	25mtr/240v/13a - Anti Twist



Hardman Extension Cable

- 110v/16 amp
- 14 mtr
- Weatherproof sockets
- 1.5mm HD cable
- German manufacture

Code: AT42050



Hardman Weatherproof Plugs & Couplings

- 110v Plug - **Code: AT42022**
- 110v Coupling - **Code: AT42023**



Hardman Junction Splitter Box

- 110v/4 way/16 amp
- Weatherproof sockets

Code: AT42021



Hardman Transformer By Carroll & Meynell

- 16amp rated
- Twin outlet
- Weatherproof comes with 2mtr cable

1.5 KVA - **Code: AT45015**

3.3 KVA - **Code: AT45010**

5 KVA - **Code: AT45011**



Hardman Trailing Socket

- Anti surge radio-frequency

1mtr/13amp/4 point - **Code: AT42001**

2mtr/13amp/4 point - **Code: AT42002**

2mtr/13amp/4 point - **Code: AT42003**



AT42001/2



AT42003

Brennenstuhl Eco Line Extension Lead

- The competitively priced quality socket outlet rail for DIY, Home and Office
- With illuminated 2 pole switch to disconnect STANDBY function from the mains
- 2 holes suitable for wall mounting
- Made of highly impact-resistant special plastic in attractive design

1.5mtr/4 way

Code: 7201T1150423

2mtr/5 way

Code: 7201T1156753



Hardman RCD Circuit Breaker

- Instant cut-off from main supply when used in conjunction with electrical equipment

Code: AT42025



Hardman Festoon Light Kit

- 110v
- 22m length cable
- 10 x bulbs (ES fitting) guards & fittings

Code: AT42026



ENGINEERS

Dormer Jobber Drills A002 Series - Metric

- Tin coated tip
- Bright finish

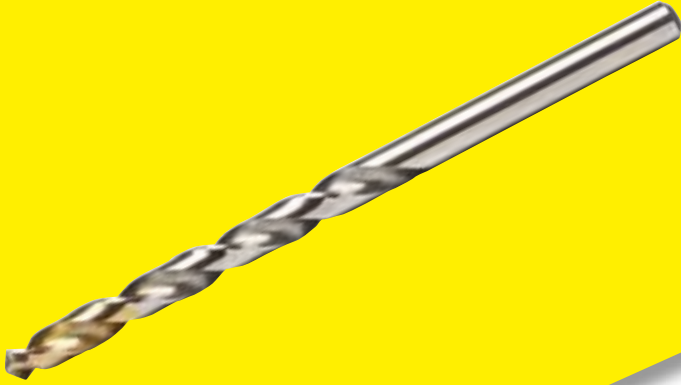

DORMER

Code	Size
0916T28	1mm
0916T31	1.5mm
0916T32	1.6mm
0916T34	2mm
0916T353	2.3mm
0916T365	2.4mm
0916T37	2.5mm
0916T375	2.6mm
0916T387	2.7mm
0916T388	2.8mm
0916T389	2.9mm
0916T39	3mm
0916T392	3.1mm
0916T41	3.2mm
0916T414	3.3mm
0916T43	3.5mm
0916T435	3.6mm
0916T437	3.7mm
0916T447	3.8mm

Code	Size
0916T45	4mm
0916T452	4.1mm
0916T453	4.2mm
0916T455	4.3mm
0916T46	4.5mm
0916T466	4.8mm
0916T467	4.9mm
0916T47	5mm
0916T472	5.1mm
0916T473	5.2mm
0916T474	5.3mm
0916T476	5.5mm
0916T487	5.7mm
0916T49	6mm
0916T492	6.1mm
0916T495	6.2mm
0916T50	6.3mm
0916T503	6.4mm
0916T504	6.5mm
0916T506	6.6mm
0916T517	6.8mm
0916T52	7mm
0916T534	7.4mm
0916T535	7.5mm
0916T54	8mm
0916T542	8.2mm
0916T545	8.5mm
0916T55	9mm
0916T555	9.5mm
0916T56	10mm
0916T562	10.2mm
0916T565	10.5mm
0916T57	11mm
0916T575	11.5mm
0916T58	12mm
0916T585	12.5mm
0916T59	13mm
0916T60	14mm

Dormer Jobber Drills A002 Series - Imperial

- Tin coated tip
- Bright finish



Code	Size
0916T0025	1/64"
0916T003	1/32"
0916T004	3/64"
0916T005	1.16"
0916T006	5/64"
0916T007	3/32"
0916T008	7/64"
0916T009	1/8"
0916T010	9/64"
0916T011	5/32"
0916T0115	11/64"
0916T012	3/16"
0916T0125	13/64"
0916T013	7/32"
0916T0135	15/64"

Code	Size
0916T014	1/4"
0916T0143	17/64"
0916T0145	9/32"
0916T0147	19/64"
0916T015	5/16"
0916T0153	21/64"
0916T0155	11/32"
0916T0157	23/64"
0916T016	3/8"
0916T0163	25/64"
0916T0165	13/32"
0916T0167	27/64"
0916T017	7/16"
0916T0173	29/64"
0916T0175	15/32"
0916T0177	31/64"
0916T018	1/2"
0916T0183	33/64"
0916T019	9/16"
0916T0196	19/32"
0916T020	5/8"

Dormer HSS Drills Long Series A110

- General purpose long series jobber drill



Code	Size	Overall Working Length - Length
0916T39LS	3mm	100mm - 66mm
0916T43LS	3.5mm	112mm - 73mm
0916T45LS	4mm	119mm - 78mm
0916T46LS	4.5mm	126mm - 82mm
0916T47LS	5mm	132mm - 87mm
0916T476LS	5.5mm	139mm - 91mm
0916T49LS	6mm	139mm - 91mm
0916T52LS	7mm	156mm - 102mm
0916T54LS	8mm	165mm - 109mm

Dormer A120 Stub Drills

- Short length general purpose drill



Code	Size
0916T31STUB	1.5mm
0916T34STUB	2mm
0916T37STUB	2.5mm
0916T39STUB	3mm
0916T414STUB	3.3mm
0916T43STUB	3.5mm

Code	Size
0916T45STUB	4mm
0916T452STUB	4.1mm
0916T453STUB	4.2mm
0916T466STUB	4.8mm
0916T467STUB	4.9mm
0916T47STUB	5mm
0916T473STUB	5.2mm
0916T49STUB	6mm
0916T504STUB	6.5mm
0916T55STUB	9mm
0916T565STUB	10.5mm
0916T57STUB	11mm

Dormer A095 Drill Set

- The bits are Titanium Nitride coated for long life
- Suitable for general purpose use on wood, plastic & metal
- These bits will fit any standard drill
- No 204 contains 1 - 10mm inc 0.5 increments
- No 201 contains 1 - 13mm inc 0.5 increments
- No 201 - 19 pce - **Code: 0916TNO201**
- No 204 - 25 pce - **Code: 0916TNO204**



Ruko HSS Drill Set

- Set 19 in Tin Box - **Code: 6561T205210**



Irwin Step Drills

- Single flute for maximum drilling control into sheet metal
- Unique flute design ensures perfect round holes in sheet metal
- Self-centring point - will not walk
- Eliminates centre punching
- Flatted shank prevents the drill bit from slipping in the chuck
- Made from industrial grade M7 high speed steel



Code	Size
4653T11101	1M 9 Hole Sizes (4mm - 12mm) 1mm increments
4653T11102	2M 5 Hole Sizes (4mm - 12mm) 2mm increments
4653T11103	3M 7 Hole Sizes (6mm - 18mm) 2mm increments
4653T11104	4M 10 Hole Sizes (4mm - 22mm) 2mm increments
4653T11105	5M 13 Hole Sizes (5mm - 35mm) 2-3mm increments
4635T10502855	Irwin 7 Size Step Drill

Dormer Taper Taps

Code	Size
0950A045TAPER	4BA
0950A049TAPER	6BA
0950F015TAPER	5/16" UNF
0950W012TAPER	3/16" BSW
0950W014TAPER	1/4" BSW
0950W015TAPER	5/16" BSW
0950W016TAPER	3/8" BSW
0950W020TAPER	5/8" BSW
0950M39TAPER	M3 x 0.50
0950M45TAPER	M4 x 0.70
0950M47TAPER	M5 x 0.80
0950M49TAPER	M6 x 1.00
0950M54TAPER	M8 x 1.25
0950M56TAPER	M10 x 1.50
0950M58TAPER	M12 x 1.75
0950M62TAPER	M16 x 2.00
0950M64TAPER	M20 x 2.50



Dormer 2nd Taps

Code	Size
0950C0152ND	5/16" UNC
0950W0122ND	3/16" BSW
0950W0142ND	1/4" BSW
0950W0152ND	5/16" BSW
0950W0162ND	3/8" BSW
0950W0202ND	5/8" BSW
0950M392ND	M3 x 0.50
0950M432ND	M3.5 x 0.60
0950M452ND	M4 x 0.70
0950M472ND	M5 x 0.80
0950M492ND	M6 x 1.00
0950M542ND	M8 x 1.25
0950M562ND	M10 x 1.50
0950M582ND	M12 x 1.75
0950M622ND	M16 x 2.00
0950M642ND	M20 x 2.50



Dormer Tap Sets

• Set includes a plug, taper & 2nd tap of specific size

Code	Size
0950M39	M3 x 0.50
0950M45	M4 x 0.70
0950M47	M5 x 0.80
0950M49	M6 x 1.00
0950M54	M8 x 1.25
0950M56	M10 x 1.50
0950M58125	M12 x 1.25
0950M58	M12 x 1.75

Dormer Plug Taps

Code	Size
0950A045PLUG	4BA
0950A049PLUG	6BA
0950F015PLUG	5/16" UNF
0950W012PLUG	3/16" BSW
0950W014PLUG	1/4" BSW
0950W015PLUG	5/16" BSW
0950W016PLUG	3/8" BSW
0950W020PLUG	5/8" BSW
0950M39PLUG	M3 x 0.50
0950M45PLUG	M4 x 0.70
0950M47PLUG	M5 x 0.80
0950M49PLUG	M6 x 1.00
0950M54PLUG	M8 x 1.25
0950M56PLUG	M10 x 1.50
0950M58PLUG	M12 x 1.75
0950M62PLUG	M16 x 2.00
0950M64PLUG	M20 x 2.50

Hanson Carbon Taps - 2nd Taps

- Carbon steel
- Suitable for forming internal threads



Code	Size
4652T8317	M4 X 0.70
4652T8322	M5 X 0.80
4652T8327	M6 X 1.0

Code	Size
4652T8334	M8 X 1.25
4652T8333	M8 X 1.0
4652T8338	M10 X 1.0
4652T8339	M10 X 1.25
4652T8340	M10 X 1.50
4652T8342	M12 X 1.25
4652T8343	M12 X 1.50
4652T8344	M12 X 1.75

Hanson Hexagon Die Nuts

- A hexagonal die with a high carbon steel, cut thread
- Mainly for hand threading applications

Code	Size
4652T9717	M4 X 0.70
4652T9722	M5 X 0.80
4652T9727	M6 X 1.0

Code	Size
4652T9734	M8 X 1.25
4652T9733	M8 X 1.0
4652T9739	M10 X 1.25
4652T9740	M10 X 1.50
4652T9742	M12 X 1.25
4652T9743	M12 X 1.50
4652T9744	M12 X 1.75



Eclipse Chuck Type Tap Wrenches

- Stepped jaws greatly extend range of taps for each wrench
- Adjustable tommy bar for tapping close to obstructions



Code	Size	Capacity
3931TE141	50mm Long	M1 - M3.5
3931TE142	65mm Long	M1 - M6
3931TE143	90mm Long	M4 - M12
3931TE145	165mm Long	M1 - M6

Eclipse Bar Type Tap Wrench

- Provides a comfortable and positive grip plus sensitivity required when tapping a blind hole
- Knurled locknut ensures a constant grip on the tap when in use



Code	Size	Capacity
3930TE240	4 1/4" Long	M1 - M6
3930TE241	6 1/4" Long	M3 - M12

Hanson T Handle Tap Wrench

- Tap wrenches designed for use with taps and on many tools turned by hand

Code: 4652T12073



Nicholson Flat File

Used by machinists, machinery builders, ship and engine builders, repairmen and others who require rapid removal of metal

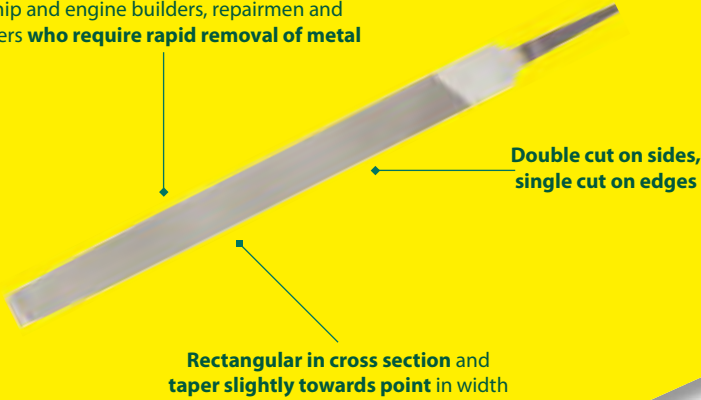

Nicholson Double Ender Saw File

- Triangular shape
- Sides and edges are single-cut from points to centre giving full use of file



- 6" - Code: 4733T0600
- 7" - Code: 4733T0700
- 8" - Code: 4733T0800

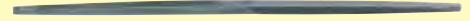

Nicholson Chainsaw Files

- Round shape
- Smooth cut



- 1/8" - Code: 4736T009
- 5/32" - Code: 4736T011
- 3/16" - Code: 4736T012
- 7/32" - Code: 4736T013



Nicholson Flat Files

- Used by machinists, machinery builders, ship and engine builders, repairmen and others who require rapid removal of metal
- Rectangular in cross section and taper slightly towards point in width
- Double cut on sides, single cut on edges
- Available in bastard, second and smooth-cut

Size	Bastard Cut	Second Cut	Smooth Cut
6"	4702T0600	4703T0600	4704T0600
8"	4702T0800	4703T0800	4704T0800
10"	4702T1000	4703T1000	4704T1000
12"	4702T1200	4703T1200	4704T1200
14"	4702T1400	4703T1400	-



Nicholson Half Round Files

- Used on concave, convex and flat surfaces
- Backs of half round bastard files are double cut
- Backs on half round second cut files longer than 6" are double cut
- Backs of all 4" & 6" files are single cut
- Flat sides of half round files are double cut

Size	Bastard Cut	Second Cut	Smooth Cut
4"	4708T0400	4709T0400	4710T0400
6"	4708T0600	4709T0600	4710T0600
8"	4708T0800	4709T0800	4710T0800
10"	4708T1000	4709T1000	4710T1000
12"	4708T1200	4709T1200	4710T1200



Nicholson Round Files

- Primarily used to file circular openings or concave surfaces
- Round shape and single cut
- Tapered slightly towards the bottom



Size	Bastard Cut	Second Cut	Smooth Cut
4"	4714T0400	4715T0400	4716T0400
6"	4714T0600	4715T0600	4716T0600
8"	4714T0800	4715T0800	4716T0800
10"	4714T1000	4715T1000	4716T1000
12"	4714T1200	4715T1200	4716T1200



Nicholson Square Files

- Used on slots, keyways and general surface filing
- Square shape and double cut
- Tapered slightly towards point
- Larger sizes frequently preferred to corresponding flat files because of heavier section and 4 filing surfaces



Size	Bastard Cut	Second Cut	Smooth Cut
4"	4711T0400	-	-
6"	4711T0600	4712T0600	4713T0600
8"	4711T0800	4712T0800	4713T0800
10"	4711T1000	4712T1000	4713T1000
12"	4711T1200	4712T1200	-
14"	4711T1400	-	-

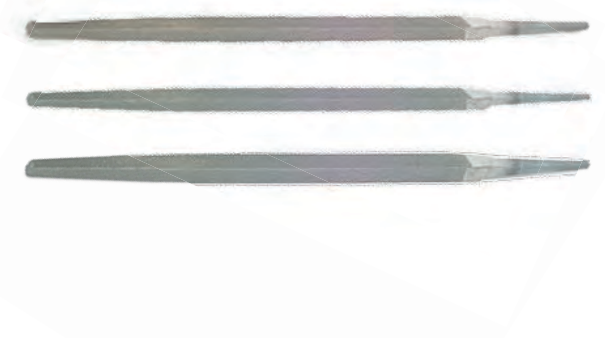

Nicholson Hand Files

- Rectangular shape
- Double-cut
- 1 safe edge
- Same coarseness as flat files of corresponding lengths



Size	Bastard Cut	Second Cut	Smooth Cut
4"	-	4706T0400	4707T0400
6"	4705T0600	4706T0600	4707T0600
8"	4705T0800	4706T0800	4707T0800
10"	4705T1000	4706T1000	4707T1000
12"	4705T1200	4706T1200	4707T1200



Nicholson Wood Rasp Files

- Used by woodworker's, hobbyists and plumbers
- Half round shape
- For use on wood & soft metals
- Single cut file teeth on edge



Size	Bastard Cut
8"	4737T0800
10"	4737T1000
12"	4737T1200



Hardman File Range

- Comes with Ergonomic Handles



Size	Bastard Cut	Second Cut	Smooth Cut
10" Hand File	ATHFB10	ATHFSC10	ATHFS10
10" Half Round File	ATHRFB10	ATHRFSC10	ATHRFS10
10" Round File	ATRFS10	ATRFSC10	ATRFS10



Size	4mm	4.8mm
8" Chain Saw File	AT4CSF8	AT48CSF8

Bahco Hand Files c/w Handle

- File handle developed according to the scientific ERGO™ process
- For filing flat surfaces, sharp corners and shoulders as well as for deburring
- High removal rate
- Shape: Edges and surfaces parallel
- Surfaces double cut, one edge uncut, one edge single cut



Size	Bastard Cut	Second Cut
6"	6205T0600B	6205T0600SC
8"	6205T0800B	6205T0800SC
10"	6205T1000B	6205T1000SC
12"	6205T1200B	-



FILES & FILE HANDLES



Bahco Flat Files c/w Handle

- File handle developed according to the scientific ERGO™ process
- Pointed shape enables the user to reach more easily into angles and corners
- Shape: Edges tapered towards the tip, surfaces parallel
- Surfaces double cut, edges single cut

Size	Bastard Cut	Second Cut
6"	-	6211T0600SC
8"	6211T0800B	6211T0800SC
10"	6211T1000B	6211T1000SC



Bahco Square Files c/w Handle

- File handle developed according to the scientific ERGO™ process
- For filing grooves, rectangular holes, inside corners and for fine-adjustment of cutting tools
- Shape: Surfaces tapered towards the tip
- Double cut

Size	Bastard Cut	Second Cut
6"	6215T0600B	6215T0600SC
8"	6215T0800B	6215T0800SC
10"	6215T1000B	-



Bahco 1/2 Round Files c/w Handle

- File handle developed according to the scientific ERGO™ process
- For filing concave and flat surfaces and large holes. Suitable for deburring work
- Shape: Edges and surfaces tapered towards the tip
- 4" and 6" fully pointed, 8" and longer semi-pointed
- Double cut

Size	Bastard Cut	Second Cut
6"	6218T0600B	6218T0600SC
8"	6218T0800B	6218T0800SC
10"	6218T1000B	6218T1000SC
12"	6218T1200B	-



FILES & FILE HANDLES

Bahco Round Files c/w Handle

- File handle developed according to the scientific ERGO™ process
- For filing holes
- Shape: Tapered towards the tip
- 4" and 6" fully pointed, 8" and longer semi-pointed
- Double cut



Size	Bastard Cut	Second Cut
6"	6220T0600B	6220T0600SC
8"	6220T0800B	6220T0800SC
10"	6220T1000B	6220T1000SC



Nicholson Hand Files c/w Handles

- Rectangular shape and double cut with one safe edge
- Same coarseness as flat file of corresponding length
- Comfortable, rubber coated ergonomic grip

8" Hand Second Cut - Code: 4706THSC8H

8" Half Round Second Cut - Code: 4709THRSC8H

8" Round Second Cut - Code: 4715TRSC8H



Nicholson 5pce Ergonomic File Set

- Assortment of machinist's files
- With ergonomic co-moulded handles
- Consists of square, round, half round, hand and threesquare

8" - Code: 4703TNFK1

10" - Code: 4703TNFK2



Hardman File Set

Contains

- Second Cut Flat File
- 1/2 Round File
- 3 Square File

Code: ATFSCSET



Hardman Rasp 3pce Set

Contains

- 8" Second Cut Flat Rasp
- 8" Bastard Cut 1/2 Round Rasp
- 8" Second Cut Round Rasp

Code: ATFRASPSET



Bahco 5pce 8" File Set

- Durable plastic handles
- In plastic roll-up wallet

Contains

- Hand Bastard
- Hand Second
- Square Bastard
- Half Round Bastard
- Round Bastard

Code: 6204T47808



RST File Handles

3" - Code: 7160TRFH03

4" - Code: 7160TRFH04

5" - Code: 7160TRFH05

6" - Code: 7160TRFH06



Python File Handles

For:

3-6" - Code: 6450T00

6-8" - Code: 6450T01

8-10" - Code: 6450T02

12-14" - Code: 6450T03



FLAT WOOD BITS



Bahco Flat Bits 9529

- Flat bit drill for drilling in wood
- Flat bit with positive cutting angle for faster drilling than with conventional bits
- High-carbon steel, heat treated all over. Hardened blade forged directly from the round shaft
- Flat bit part and shaft are ground
- Lacquered for rust protection



Code	Size
6173T49	6mm x 156mm
6173T54	8mm x 156mm
6173T56	10mm x 156mm
6173T58	12mm x 156mm
6173T59	13mm x 156mm
6173T60	14mm x 156mm
6173T62	16mm x 156mm
6173T83	17mm x 156mm
6173T63	18mm x 156mm
6173T84	19mm x 156mm
6173T64	20mm x 156mm
6173T65	22mm x 156mm
6173T66	24mm x 156mm
6173T67	25mm x 156mm
6173T675	26mm x 156mm
6173T687	28mm x 171mm
6173T69	30mm x 171mm
6173T707	35mm x 171mm
6173T718	38mm x 171mm
6173T724	40mm x 171mm

Bahco Flat Bits - Long Series 9531

- Extra long flat bit drill for drilling in wood
- Flat bit with positive cutting angle for faster drilling than with conventional bits
- High-carbon steel, heat treated all over. Hardened blade forged directly from the round shaft
- Flat bit part and shaft are ground
- Lacquered for rust protection



Code	Size
6174T49	6mm x 400mm
6174T54	8mm x 400mm
6174T56	10mm x 400mm
6174T58	12mm x 400mm
6174T59	13mm x 400mm
6174T60	14mm x 400mm
6174T62	16mm x 400mm
6174T84	19mm x 400mm
6174T64	20mm x 400mm
6174T65	22mm x 400mm
6174T66	24mm x 400mm
6174T67	25mm x 400mm
6174T687	28mm x 400mm
6174T69	30mm x 400mm
6174T692	32mm x 400mm

Code	Size
4677T49	6mm
4677T54	8mm
4677T58	12mm
4677T60	14mm
4677T62	16mm
4677T63	18mm
4677T84	19mm
4677T64	20mm
4677T65	22mm
4677T66	24mm
4677T67	25mm
4677T687	28mm
4677T692	32mm
4677T707	35mm
4677T718	38mm
4677T724	40mm

Irwin Blue Groove Flat Bit

- Double cutting spurs scribe outside of hole, reducing breakout
- Thicker cutting edge for longer drilling life
- Blue-groove point and cutting edge for faster chip removal
- 10% larger shank - added durability
- 1/4" quick change shank



Code	Size
4677T88608	8 x 400mm
4677T88610	10 x 400mm
4677T88612	12 x 400mm
4677T88613	13 x 400mm
4677T88614	14 x 400mm
4677T88616	16 x 400mm
4677T88618	18 x 400mm
4677T88619	19 x 400mm
4677T88620	20 x 400mm
4677T88622	22 x 400mm
4677T88625	25 x 400mm
4677T88628	28 x 400mm
4677T88632	32 x 400mm
4677T88635	35 x 400mm

Irwin Blue Groove Flat Bit - Long

- Double cutting spurs scribe outside of hole, reducing breakout
- Thicker cutting edge for longer drilling life
- Blue-groove point and cutting edge for faster chip removal
- 10% larger shank - added durability
- 1/4" quick change shank



FLAT WOOD BITS



Hardman Flat Wood Bit

- Titanium coated
- Designed for use in electrical drills
- Delivers fast hole boring in wood
- 1/4" quick change shank



Code	Size
AT32001	6mm
AT32002	8mm
AT32003	10mm
AT32004	13mm
AT32005	16mm
AT32006	19mm
AT32007	22mm
AT32008	25mm
AT32009	29mm
AT32010	32mm
AT32011	35mm
AT32012	38mm

Bosch Selfcut Flat Bits

- For rapid clean drilling of larger diameter holes
- Self-cutting threaded point and two side cutters
- Ground chip breakers
- 1/4" hexagonal shank



Code	Size
BTFB06	6mm x 152mm
BTFB08	8mm x 152mm
BTFB10	10mm x 152mm
BTFB12	12mm x 152mm
BTFB13	13mm x 152mm
BTFB14	14mm x 152mm
BTFB16	16mm x 152mm
BTFB17	17mm x 152mm
BTFB18	18mm x 152mm
BTFB19	19mm x 152mm
BTFB20	20mm x 152mm

Code	Size
BTFB22	22mm x 152mm
BTFB24	24mm x 152mm
BTFB25	25mm x 152mm
BTFB26	26mm x 152mm
BTFB28	28mm x 152mm
BTFB30	30mm x 152mm
BTFB32	32mm x 152mm
BTFB35	35mm x 152mm
BTFB36	36mm x 152mm
BTFB38	38mm x 152mm
BTFB40	40mm x 152mm



Bulldog All Season Digging Spade

Code: 3700TBDS



GARDENING

Bulldog

All Season Digging Fork

- Dimensions 11.5" x 7.5" (290 x 180mm)
- Handle 28" (711mm)

Code: 3700TBDF



Bulldog

All Season Garden Rake

- Dimensions 4" x 12" (100 x 305mm)
- Handle 54" (1325mm)

Code: 3700TBCR



Bulldog

All Season Lawn Rake

- Dimensions 12" x 17" (305 x 432mm)
- Handle 54" (1325mm)

Code: 3700TBWR



Bulldog

All Season Edging Knife

- Dimensions 7" x 8" (177 x 204mm)
- Handle 28" (711mm)

Code: 3700TBEK



Bulldog

All Season Dutch Hoe

- Dimensions 7" x 5" (180 x 126mm)
- Handle 54" (1325mm)

Code: 3700TBDH

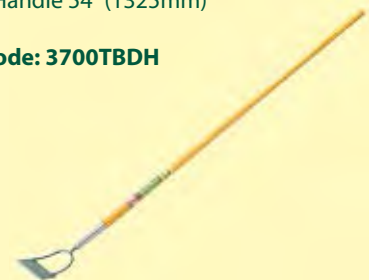

Bulldog Hedge Shear Premier

- Longer handles for extra reach
- Wavy blade design
- Adjustable blade tension

Code: 3700TBD2232Y2



Bulldog Evergreen Bypass Lopping Shears

- Adjustable blade tension
- Wavy blade design
- Handle length 32"

Code: 3700TBD1103RW



HAMMERS



Stanley Fatmax High Velocity Framing Hammer

- 14oz Curve Claw - Code: 2730T151148
- 14oz Rip Claw - Code: 2730T151123
- 15oz Rip Claw - Code: 2730T151124



Stanley Blue Strike Claw Hammer

- Fully forged and heat treated head for strength and performance
- Flock filled vinyl grip impervious to oil and most solvents
- Tubular oval shaft combines strength with a lightweight feel

- 16oz - Code: 2730T1600
- 20oz - Code: 2730T2000



Stanley Fibreglass Curved Claw Hammer

- Heat treated and rim tempered for durability and safety
- Forged high carbon steel head for durability
- Fibreglass handle absorbs shock and vibration
- Textured rubber grip for comfort

- 16oz - Code: 2730T151529
- 20oz - Code: 2728T151628



Stanley Fatmax Xtreme Anti-Vibe Claw Hammer

- One piece solid forged head
- 75% larger strike face
- Magnetic nail starter

- Claw**
- 16oz - Code: 2730T551162
- 20oz - Code: 2730T151164

- Rip Claw**
- 16oz - Code: 2500T551163
- 20oz - Code: 2500T551165

Hardman Curved Claw Hammer Fibreglass Shaft

- 16oz or 20oz hammer
- Fibreglass shaft

- 16oz - Code: AT20002
- 20oz - Code: AT20003

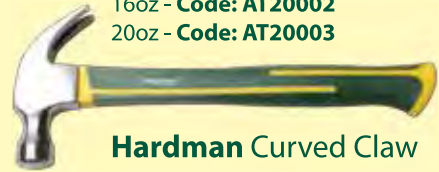

Hardman Curved Claw Hammer All Steel Hero Grip

- 16oz or 20oz hammer
- Steel shaft

- 16oz - Code: AT20007
- 20oz - Code: AT20008



Estwing Vinyl Grip Curved Claw Hammer

- For driving and withdrawing common finishing nails
- Shock-reduction nylon-vinyl grip
- One piece forging
- Fully polished

- 16oz - Code: 7120T1600V
- 20oz - Code: 7120T2000V
- 24oz - Code: 7120T2400V

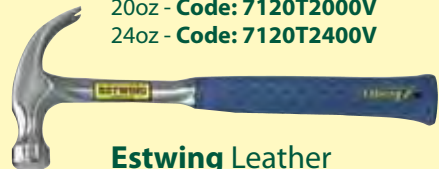

Estwing Leather Grip Claw Hammer

- One piece solid forged steel
- Hardened & tempered head
- Fully polished

- 16oz - Code: 7120T1600L
- 20oz - Code: 7120T2000L
- 24oz - Code: 7120T2400L



Stanley Fatmax AVX Claw Hammers

- One piece solid forged head
- New soft grip
- Patented tuning fork design plus 24 torque stabilising bars
- 100% crack detection inspection

- 20oz - Code: 2730T151538





HAMMERS

Estwing Steel Shaft Claw Hammer

- Smooth face
- Fibreglass shaft
- Injection moulded grip

16oz - Code: 7120TEMR16C
20oz - Code: 7120TEMR20C



Hardman Ball Pein Hammer

- Hardened & tempered striking surfaces

8oz - Code: AT85005
12oz - Code: AT85006
16oz - Code: AT85007
24oz - Code: AT85008
32oz - Code: AT85009
40oz - Code: AT85010
48oz - Code: AT85011



Also available in fibreglass shafts

16oz - Code: AT85017
24oz - Code: AT85018
32oz - Code: AT85019

Estwing Masons Brick Hammer

- Fully polished
- Patented end cap
- Shock-reduction Nylon-vinyl grip

20oz - Code: 7125T2000
24oz - Code: 7125T2400



Hardman Hickory Shaft Brick Hammer

- Ground striking face and cutting edge
- Hickory shaft
- 20oz

Code: AT20035



Hardman All Steel Brick Hammer

- Polished head
- Ground striking face & cutting edge
- Vinyl grip

Code: AT20036



Stanley Fatmax Anti-Vibe Brick Hammer

- Cutting hammer for cutting brick, masonry tile & concrete block
- Blade has hardened cutting edge designed to score materials before striking
- Patented Anti-Vibe technology reduces vibration transmitted to wrist & elbow
- One piece forged construction for strength & durability
- 20oz

Code: 2737T154022



Stanley Steelmaster Brick Hammer

- Fully heat treated carbon steel head for strength, durability & safety
- Soft grip ergonomic handle
- 5 ton force fit head to handle assembly for improved safety
- Sharp chisel edge for cutting bricks and slate
- 18oz

Code: 2730T151039



Wood Shaft / Handles

Ball Pein Hammer Shafts

10"/11" - Code: 5950T1000
12"/13" - Code: 5950T1200
14"/15" - Code: 5950T1400
16" - Code: 5950T1600
18" - Code: 5950T1800

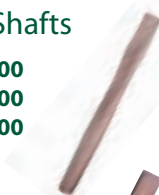

Hand / Felling Axe Shaft

16" - Code: 5955T1600
36" x 2 1/2" Eye
Code: 5956T3600
36" x 3 3/4" Eye
Code: 5956T542H36



Broom Handles

48" x 15/16" - Code: 5959T4800
48" x 11/8" - Code: 5959T910R48
72" x 11/8" - Code: 5959T910R72



Claw Hammer Shafts

14" - Code: 5951T1400



Spade Shafts

28" Straight Taper T
Code: 5961T700A28
28" Bent Taper T
Code: 5961T705A28



Club Hammer Shafts

10" - Code: 5952T1000

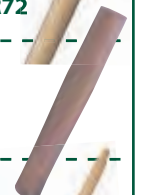

Pin Hammer Shaft

13" - Code: 5953T1300

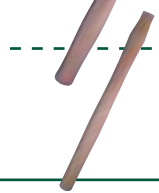

Sledge Hammer Shaft

24" - Code: 5954T2400
30" - Code: 5954T3000
36" - Code: 5954T3600



HAMMERS



Hardman Club Hammer Hickory Shaft

- Ground striking faces

2 1/2lb - Code: AT20014

4lb - Code: AT20015



Hardman Club Hammer Fibreglass Shaft

- Ground striking faces
- Shock absorbent fibreglass shaft
- Outlasts traditional hickory

2 1/2lb - Code: AT20011

4lb - Code: AT20012



Estwing Club Hammer

- One piece construction
- Polished and chamfered striking surface
- Bonded blue vinyl grip

2lb - Code: 7128T2000

3lb - Code: 7128T3000



Stanley Graphite Handle Club Hammer

- Full length graphite core shaft
- Fully hardened tempered steel head
- Graphite core in a polycarbonate sleeve provides excellent overstrike protection

35oz - Code: 2737T154922

52oz - Code: 2737T154924



Estwing Dry Wall Hammer

- Designed for dressing stonework
- Polished and scored head
- Bonded blue vinyl grip

11oz - Code: 7125T1400V



Hardman Double Ended Scutch Hammer

- Hickory shaft
- Ground striking face & cutting edge

Code: AT20034



Hardman Hickory Shaft Sledge Hammer

- Ground striking faces

7lb - Code: AT20025

10lb - Code: AT20026

14lb - Code: AT20027



Hardman Fibreglass Shaft Sledge Hammer

- Shock absorbent fibreglass shaft
- Outlasts traditional hickory

7lb - Code: AT20030

10lb - Code: AT20031

14lb - Code: AT20032



Pennine Hammer Wedges

- For securing replacement hammer shafts

Size 1 - Code: 6529T1

Size 2 - Code: 6529T2

Size 3 - Code: 6529T3

Size 4 - Code: 6529T4

Size 5 - Code: 6529T5

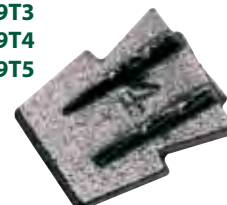



HAMMERS

Thor Rawhide/Copper Hammer

- 25 x 230mm - Code: 4551TA208
- 32 x 270mm - Code: 4551T1210
- 38 x 305mm - Code: 4551T2212
- 44 x 305mm - Code: 4551T3214
- 50 x 355mm - Code: 4551T4216
- 70 x 915mm - Code: 4551T5222



Thor Rawhide Hammer - Wood Shaft

- Pure buffalo hide inserts

- 25 x 230mm - Code: 4552TA8
- 32 x 270mm - Code: 4552T110
- 38 x 305mm - Code: 4552T212
- 44 x 305mm - Code: 4552T314
- 50 x 355mm - Code: 4552T416
- 70 x 915mm - Code: 4552T522



Thor Rawhide Hammer - Plastic Shaft

- Pure buffalo hide inserts

- 32 x 270mm - Code: 4569T10PH
- 38 x 305mm - Code: 4569T212P



Thor Copper Faced Hammer

- Wood shaft
- Pure copper inserts

- 25 x 230mm - Code: 4550TA308
- 32 x 270mm - Code: 4550T1310
- 38 x 305mm - Code: 4550T2312
- 44 x 305mm - Code: 4550T3314
- 50 x 355mm - Code: 4550T4316
- 70 x 915mm - Code: 4550T5322

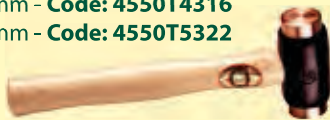

Thor Nylon Hammer

- Durable white nylon inserts
- Light to heavy use
- Model 708 has a wood shaft

- 25mm - Code: 4554T708
- 32mm - Code: 4554T710
- 38mm - Code: 4554T712
- 44mm - Code: 4554T714
- 50mm - Code: 4554T716
- 63mm - Code: 4554T720



Thor Deadblow Nylon Hammer

- Hollow die cast shot filled head
- Prevents rebound
- Delivers high impact "dead blows"

- 32 x 275mm - Code: 4555T1010
- 38 x 305mm - Code: 4555T1212
- 44 x 310mm - Code: 4555T1414
- 50 x 325mm - Code: 4555T1616
- 63 x 370mm - Code: 4555T2020

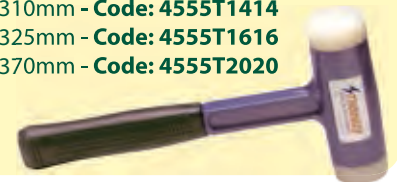

Thor Black Rubber Mallet

- Gentle but firm blow
- Ideal for outdoor use
- Self wedging shafts

- 40 x 80mm - Code: 4561T951
- 54 x 90mm - Code: 4561T952
- 64 x 113mm - Code: 4561T953
- 74 x 127mm - Code: 4561T954
- 90 x 139mm - Code: 4561T957



Thor White Rubber Mallet

- Does not discolour
- Does not leave marks on work surfaces
- Self wedging shafts

- 54 x 90mm - Code: 4561T952W
- 64 x 113mm - Code: 4561T953W
- 74 x 127mm - Code: 4561T954W
- 90 x 139mm - Code: 4561T957W



HANDSAWS



Bahco 244 Saw

20" - Code: 6167T24420

22" - Code: 6167T24422



Irwin Jack 880 Universal Saw

20" - Code: 6453T88020

22" - Code: 6453T88022

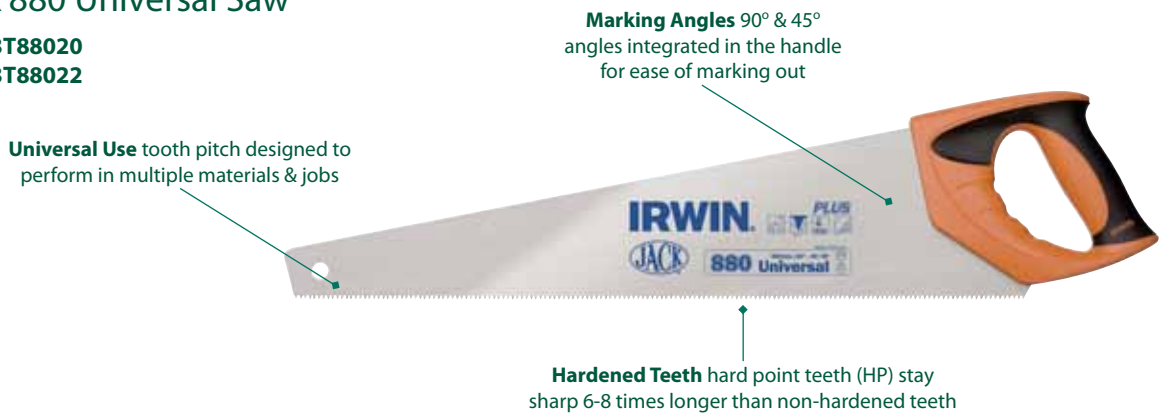

Stanley Heavy Duty Hardpoint Saw

20" - Code: 2500T1200910

22" - Code: 2500T120091



Hardman Hardpoint Handsaw Triple Pack

22" - Code: AT35002TRIPLE

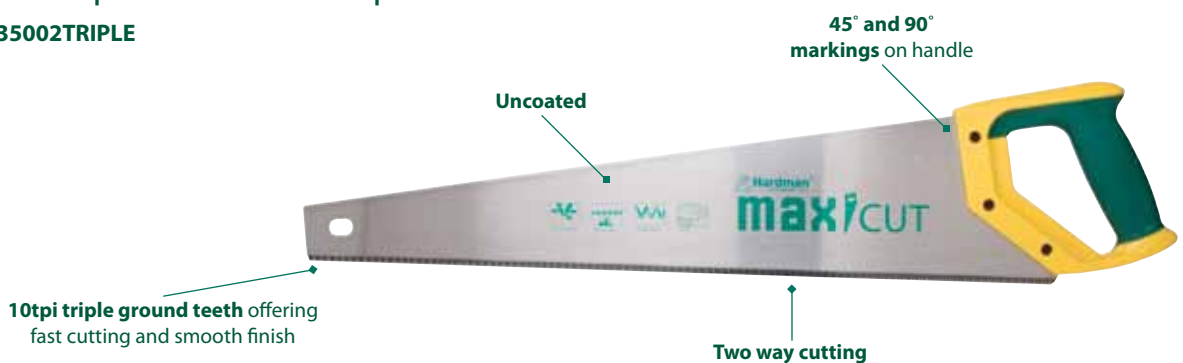



IRWIN



SPEAR & JACKSON

HANDSAWS

Bahco Barracuda

- Thicker blade for increased stability and precision
- Universal toothing, hardpoint teeth for long lasting sharpness
- Saw blade for cutting medium thick materials
- Screwed 2-component handle can be used for approximate 45° and 90° marking guide

22" - Code: 6167TBARRACUDA



Bahco 22" Hardpoint Handsaw

- Professional handsaw for cutting all types of wood
- Universal toothing with hardpoint teeth for long lasting sharpness
- Screwed one-piece plastic handle
- 22" length

Code: 6167TNP2224P



Irwin Jack

22" 990 Fine Hardpoint Handsaw

- Finger rest for maximum control
- Water based lacquer gives four times better rust protection
- 0.85mm blade
- Light and strong soft-grip handle for increased grip and enhanced comfort
- Handle with marked 45° and 90° angles

Code: 6453T2200



Irwin Jack 22" 770 Crosscut Handsaw

- Finger rest for maximum control
- Water based lacquer gives four times better rust protection
- 0.85mm blade
- Light and strong soft-grip handle for increased grip and enhanced comfort
- Handle with marked 45° and 90° angles

Code: 6453T2200C



Irwin Jack Universal Evo Saw

- High angled nose - Increases blade stability
- Flush Cutting - To cut off at surface level
- Finger rest for maximum control
- Water based lacquer gives four times better rust protection
- 0.85mm blade
- Light and strong soft-grip handle for increased grip and enhanced comfort
- Handle with marked 45° and 90° angles

Code: 6453TEVO



Spear & Jackson

Predator 22" Hardpoint Saw

- A general purpose saw for use across the grain
- Fast cut - rapid, clean cutting action
- Rigid blade minimises 'whip' and vibration
- Ideal for timber, hardwood, chipboard and MDF
- Comfortable handle - finger rest for maximum control
- Handle with marked 45° and 90° angles

Code: 4071TPREDATOR



Spear & Jackson

Predator 20" UPVC Woodsaw

- Fast cut - rapid, clean cutting action
- Rigid blade minimises 'whip' and vibration
- Ideal for cutting sills, trims and plastic pipes
- Comfortable handle - finger rest for maximum control
- Handle with marked 45° and 90° angles

Code: 4071TPREDUPVC



Spear & Jackson

Predator 22" Second Fix Woodsaw

- A fine cutting saw for use across the grain
- Fast cut - rapid, clean cutting action
- Rigid blade minimises 'whip' and vibration
- Ideal for planed wood, skirting, architraves and dado rails
- Comfortable handle - finger rest for maximum control
- Handle with marked 45° and 90° angles

Code: 4071TPREDSF

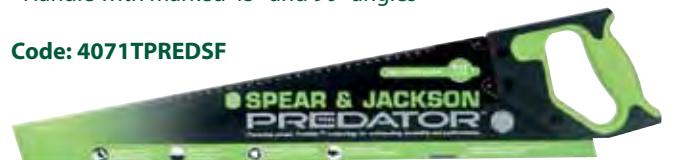

HANDSAWS



Spear & Jackson

Predator 22" X Fleam Tooth Woodsaw

- A fine cutting saw for use across the grain
- Triple ground tooth configuration
- Fast cut - rapid, clean cutting action
- Rigid blade minimises 'whip' and vibration
- Ideal for a smooth finish on soft woods
- Comfortable handle - finger rest for maximum control
- Handle with marked 45° and 90° angles

Code: 4071TPREDB98X

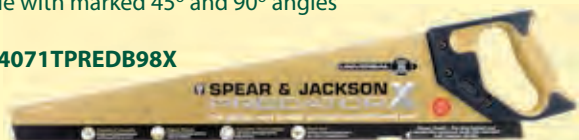

Spear & Jackson

Predator 20" Laminate Woodsaw

- A hardpoint saw delivering a fine cut
- Fast cut - rapid, clean cutting action
- Rigid blade minimises 'whip' and vibration
- For use on laminate flooring, formica and beading
- Comfortable handle - finger rest for maximum control
- Handle with marked 45° and 90° angles

Code: 4071TPREDLAM

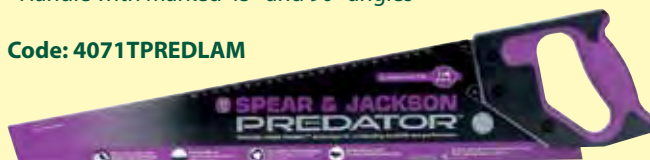

Spear & Jackson

Predator 22" First Fix Woodsaw

- A fast cutting saw for use along and across the grain
- Fast cut - rapid, clean cutting action
- Rigid blade minimises 'whip' and vibration
- Use with all rough sawn timber
- Comfortable handle - finger rest for maximum control
- Handle with marked 45° and 90° angles

Code: 4071TPREDF

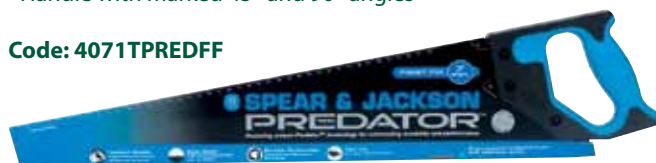

Stanley Fatmax Saws

- Bi-material handle screwed and ultrasonically welded for comfort and security
- Teeth are precision set
- 3 sided precision ground teeth offer razor sharp cutting edges
- Induction hardened teeth stay sharper twice as long than previous model

20" - 7TPI - Code: 2500T315288

22" - 7TPI - Code: 2500T315289

20" - 11TPI - Code: 2500T315599

22" - 11TPI - Code: 2500T315244



Irwin Jack Tenon Saw

- Soft-grip handle for extra comfort
- 10"/250mm blade
- 40% faster than a traditional saw
- Very fine cut for fine carpentry and especially for use with a mitre box
- Razor sharp hard point teeth
- Cuts along and across the grain

10" - Code: 4676TYP2055250

12" - Code: 4676TYP2055300



Bahco Prizecut Tenon Saw 12"

- For fine and medium thick materials
- Hardpoint teeth for long lasting sharpness

Code: 6168T1200



Stanley Fatmax Tenon/Back Saw

- 11 and 13 teeth per inch for a fine finish
- Reinforced back for extra rigidity makes a straighter cut
- Induction hardened teeth stay sharper twice as long as previous model
- Finger rest - ergonomic design useful for extra control when starting a cut
- 3 sided precision ground teeth offer razor sharp cutting edges at every stage of the stroke
- Bi-material handle screwed and ultrasonically welded for comfort and security
- Handle marked with 45° and 90° angles

12" - 11TPI - Code: 2584T517199

14" - 11TPI - Code: 2584T517201

14" - 13TPI - Code: 2584T517202





HANDSAWS

Spear & Jackson 12" Workhouse Brass Back Tenon Saw

- For general use cutting along and across the grain with a standard finish
- Finger rest for both left and right handed users
- Traditional wooden handle
- Precision cross ground teeth for extra sharpness

12" x 15pts - **Code: 4071TB2312**



Irwin Jack 13" Veneer Floorboard Saw

- Ultra fine 12tpi 13"/325mm long blade
- Finger-rest for maximum control
- Water based lacquer gives four times better rust protection
- Hard Point teeth (HP) stay sharp for longer

Code: 4676TXP2049325

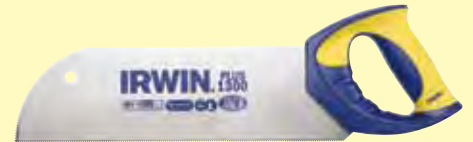

Stanley Fatmax 12" Floorboard Saw

- Teeth on curved end of blade helps to start off a cut in floorboards
- Induction hardened teeth lasting twice as long as previous products
- Bi-material handle screwed and ultrasonically welded for comfort and security
- Finger rest - ergonomic design, useful for extra control when starting a cut
- 13 teeth per inch

Code: 2584T517204



Bahco 15" Toolbox Saw

- General purpose saw with very fine hard-point teeth for smooth sawing in a wide variety of materials including aluminium, plastic, laminates, wood and chipboard
- Fleam-toothing
- Screw plastic handle
- Toolbox size

Code: 6167T300015



Spear & Jackson Coping Saw

- For cutting and shaping wood
- Position blades at any angle
- 71-CP7R coping saw blades to suit
- Plus packs of blades

Code: 4110T70CP1R



Stanley Fatmax Coping Saw

- Hardened tempered blade for long life
- Steel back prevents bending for strong, true straight cuts
- New soft grip handle for comfort

Code: 2598T015106



Bahco Coping Saw

- Ideal for cutting curves, slots & shapes
- Nickel-plated steel frame
- Interchangeable blade fitted on retaining pins, turnable 360°
- 165mm

Code: 6350T301



Stanley Coping Saw Spare Blades

Card of 4
Code: 2598T015061

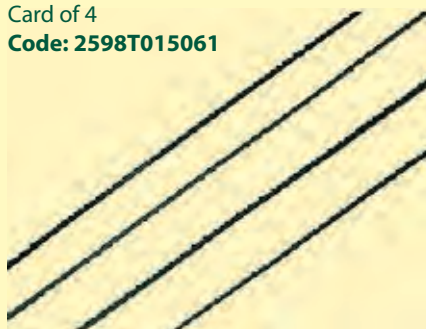

Bahco Blade Pack

- Hardened and tempered carbon steel
 - Teeth milled and set
 - 14TPI
 - Pack of 5
- Code: 6350T3035P**

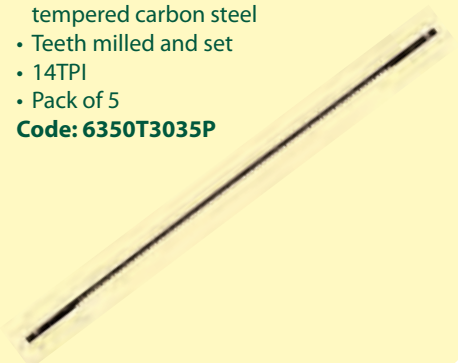

HANDSAWS



Bahco Model 10 Ergo Bowsaw

- Heavy duty bowsaw
- High quality steel frame
- Corrosion and high impact orange enamel paint
- Designed for demanding applications and tough environments such as construction sites
- Better and stronger blade fitting for easy and safe blade change

24" - Code: 6169T1024
30" - Code: 6169T1030



Bahco 21" Bowsaw 332

- Professional bowsaw for all-round use
- Pointed nose makes the saw well suited for use in tight spaces and is ideal for pruning and roofing work
- High quality steel frame
- Corrosion and high impact orange enamel paint

21" - Code: 6169T332



Bahco Bowsaw 51 Dry Cut Blades

21" - Code: 6171T2100
24" - Code: 6171T2400
30" - Code: 6171T3000
36" - Code: 6171T3600



Bahco Bowsaw 23 Wet Cut Blades

21" - Code: 6172T2100
24" - Code: 6172T2400
30" - Code: 6172T3000



Stanley Fatmax 26" Concrete Saw

- 1.4 teeth per inch
- Specially designed 26" blade ideal for cutting cellular blocks and soft stone
- Induction hardened teeth stay sharper twice as long as previous model
- Bi-material handle screwed and ultrasonically welded for comfort and security
- Handle marked with 45° and 90° angles

Code: 2586T2600



Irwin Jack Xpert Light Concrete Saw

- 28"/700mm
- Triple-ground tooth technology not only increases efficiency but also optimises cutting performance on both push and pull strokes - so you don't have to work so hard
- Soft grip handle with finger guide

Code: 4676T2800



Bahco 255 Concrete Saw

- 30" Tungsten Carbide Tipped
- Ideal for lightweight cellular block
- Plastic handle

Code: 6168T3000



Hardman Jab Saw

- Triple ground teeth
- Hardened teeth
- Two way cutting
- Fast cut
- 150mm

Code: AT35004



Irwin Jab/Drywall Saw

- 1.5mm rigid blade
- Hardened & tempered blade
- Sharpened tip
- Aggressive tooth design

Code: 6453T10505705



Bahco Drywall Saw

- Special compass saw for cutting holes in drywalls
- The sturdy blade, with triple-edge teeth, ends in a sharp point which, together with the comfortable 2-component handle, makes it perfect to use for the penetration
- Thereafter the cutting can be continued to create the desired shape of the hole in the plasterboard

Code: 6167TPC6DRY

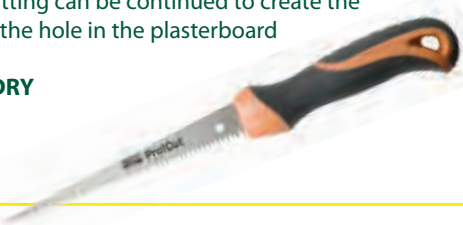

Stanley Fatmax Plasterboard/Jab Saw

- 7 teeth per inch
- Ideal for punching through plasterboard
- Anti-slip ergonomic bi-material handle for optimum user comfort
- Triple bevelled toothing for 50% quicker and easier cutting
- Sharp point for piercing board

Code: 2500T020556

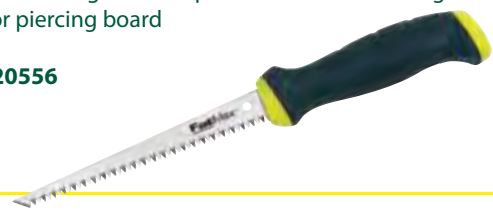



HANDSAWS

Irwin Jack I-125 Hacksaw

- Irwin Hacksaw frames are built to meet the professionals demanding needs. The durable Irwin frames make cutting quick and easy
- 125kg blade tension to ensure accurate cutting
- Soft touch handle gives solid and slip-free grip

Code: 4615T10504407



Stanley Fatmax 5 in 1 Hacksaw

- **5 positions uniquely versatile**
- 45° flush cut position
- 90° standard position
- Long pad saw position
- Short pad saw position
- Low profile position
- **Lightweight frame with 150kg blade tension**
- **Integrated storage for replacement blades**
- **Comfort grip handle**

Code: 2584T020108



Bahco 12" Light Hacksaw Frame

- A comfortable hacksaw frame for all-round use, slim design improves access in confined spaces and makes storage easy
- Special grip at the front provides good support for the guiding hand for superb performance
- Alternative 90° blade mounting for flush cutting

Code: 6167T317



Bahco 12" Hacksaw Frame

- A professional hacksaw frame
- Comfortable soft grip handles
- Steel tube core with plastic covering allows high blade tension for straight and accurate cuts
- Alternative 55° blade mounting for flush cutting

Code: 6167T319



Bahco 12" Professional Hacksaw Frame

- A professional and strong hacksaw frame
- Very high blade tension for straight and accurate cuts
- Blade tensioning mechanism with blade retaining spring for easy blade change
- Strong rectangular back section for blade storage, can also be used as a compass saw
- Alternative 55° blade mounting for flush cutting

Code: 6160T12005



Bahco 12" Ergo Hacksaw Frame

- Frame developed according to the scientific ERGO process
- Solid aluminium frame that allows very high blade tension for straight and accurate cuts
- Centred blade for balance and precision
- Quick-change blade tensioning mechanism with blade retaining spring for quick and easy blade change
- Alternative 55° blade mounting for flush cutting

Code: 6160T325



Bahco Bi-metal Hacksaw Blades

- 24 TPI - Code: 6202T390624
- 18 TPI - Code: 6202T390618
- 32 TPI - Code: 6202T390632

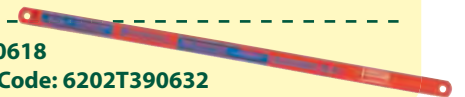

Stanley Heavy Duty Hacksaw

- Bi-material ergonomic frame and handle for superior comfort and grip
- Patented quick blade change and lever to change tension suitable for application
- 80kg permanent blade tension for faster cutting
- 2 blade positions 90° and 45°
- Easy tension adjustment using a tightening wheel

Code: 2601T120110



Spear & Jackson 20T Hacksaw

- The world famous, best selling hacksaw
- Tubular steel frame
- Die cast handle
- Professional hacksaw

Code: 4110T7020TR



HANDSAWS



Hardman Hacksaw

- 300mm/12" Hacksaw
- High tension blade
- Tightening function
- Blade can be positioned at 45° and 90°

Code: AT35005



Eclipse Hacksaw Blades Plus 30 All Hard Flex

- Super hardened high performance and long life
- Manufactured from top quality high speed steel
- Will suit virtually all popular sawing machines / frames

- 12" x 14TPI - Code: 3900T120001814
- 12" x 18TPI - Code: 3900T120001818
- 12" x 24TPI - Code: 3900T120001824
- 12" x 32TPI - Code: 3900T120001832



Starrett Red Stripe Blades/ HSS Hacksaw Blades

- Ideal when the blade is not subject to bending and twisting stresses
- Uniformly hardened blade holds the edge when cutting hard-to-machine alloys, maintaining the straightness of the cut

- 18TPI - Code: 8470TRS1218
- 24TPI - Code: 8470TRS1224
- 32TPI - Code: 8470TRS1232



Starrett Bi-Metal Unique Blades

- A patented solid state diffusion process produces the industry's most advanced bi-metal hacksaw blade
- Massive increase in tooth strength and reduction in breakage and fracture when compared against traditional bi-metal blades
- Excellent for interrupted cuts in cramped places or where the blade is subject to bending or twisting stresses

- 18TPI - Code: 8470TKBS121810
- 24TPI - Code: 8470TKBS122410
- 32TPI - Code: 8470TKBS123210



Hardman Junior Hacksaw

- Powder coated Steel Frame
- Fitted quality rubber finger guard
- Supplied with 32tpi blade for metal and 14tpi for wood

Code: AT34001



Spear & Jackson Junior Hacksaw Frame

- Epoxy coated steel frame
- Metal cutting blade
- Uses 71-132R blades

Code: 4110T7014JR



Bahco 6" Junior Hacksaw

- Junior hacksaw with orange powder coated steel wire frame

Code: 6350T239



Stanley Quick Release Junior Hacksaw

- Square rigid tube mounting for strength
- Moulded handle - lightweight and strong
- Level incorporated in the handle allowing a rapid change in the blade

Code: 2604T015218



Stanley Mini Hacksaw

- Metal mini saw ideal for small areas with limited access
- Allows the use of truncated sections of blade
- Fine adjustment of the blade length gives greater range of applications
- 300mm

Code: 2500T020807



Junior Hacksaw Blades

Bahco

- Spare blade for junior hacksaw frames
- Made of hardened and tempered carbon steel, teeth milled and set

6350T2283210P



Stanley

Card of 5 blades - Code: 2605T0600



Hardman

- Pack of 10 replacement blades

Code: AT34002



Bosch Holesaws

Progressive tool strip
 For a powerful bite and accelerated chip clearance



HSS bi-metal
 With 8% cobalt alloy for extreme resilience and long lifetime

Power-Change adaptor
 For fast and safe attachment and release of the pilot drill bit and holesaw, with just one click

Code	Size	Code	Size	Code	Size
BT2608584612	14mm	BT2608584634	48mm	BT2608584656	102mm
BT2608584613	16mm	BT2608584635	51mm	BT2608584657	105mm
BT2608584614	17mm	BT2608584636	52mm	BT2608584658	108mm
BT2608584615	19mm	BT2608584637	54mm	BT2608584659	111mm
BT2608584616	20mm	BT2608584638	56mm	BT2608584660	114mm
BT2608584617	21mm	BT2608584639	57mm	BT2608584661	121mm
BT2608584618	22mm	BT2608584640	59mm	BT2608584662	127mm
BT2608584619	24mm	BT2608584641	60mm	BT2608584663	140mm
BT2608584620	25mm	BT2608584642	64mm	BT2608584664	140mm
BT2608584621	27mm	BT2608584643	65mm	BT2608584676 Arbor fits all	
BT2608584622	29mm	BT2608584644	67mm		
BT2608584623	30mm	BT2608584645	68mm		
BT2608584624	32mm	BT2608584646	70mm		
BT2608584625	33mm	BT2608584647	73mm		
BT2608584626	35mm	BT2608584648	76mm		
BT2608584627	37mm	BT2608584649	79mm		
BT2608584628	38mm	BT2608584650	83mm		
BT2608584629	40mm	BT2608584651	86mm		
BT2608584630	41mm	BT2608584652	89mm		
BT2608584631	43mm	BT2608584653	92mm		
BT2608584632	44mm	BT2608584654	95mm		
BT2608584633	46mm	BT2608584655	98mm		



Starrett Constant Pitch Holesaws



Starrett Bi Metal Constant Pitch Hole Saws have 6 teeth per 25mm/inch and are ideal for thinner gauge materials. The Constant Pitch provides a smooth cut, with minimal tendency to bite or snag on contact with irregular surfaces. Cutting depth 41mm (1 5/8"). A range of general purpose and specialist kits are available, featuring the most popular sizes of saw.

Code	Size	Code	Size	Code	Size
8470TCPSH0096	14mm	8470TCPSH0134	44mm	8470TCPSH0312	89mm
8470TCPSH0058	16mm	8470TCPSH1136	46mm	8470TCPSH0358	92mm
8470TCPSH1016	17mm	8470TCPSH0178	48mm	8470TCPSH0334	95mm
8470TCPSH0034	19mm	8470TCPSH0200	51mm	8470TCPSH0378	98mm
8470TCPSH2532	20mm	8470TCPSH0216	52mm	8470TCPSH0400	102mm
8470TCPSH1036	21mm	8470TCPSH0218	54mm	8470TCPSH0418	105mm
8470TCPSH0078	22mm	8470TCPSH0214	57mm	8470TCPSH0414	108mm
8470TCPSH0100	25mm	8470TCPSH0256	59mm	8470TCPSH0438	111mm
8470TCPSH0112	38mm	8470TCPSH0238	60mm	8470TCPSH0412	114mm
8470TCPSH0114	32mm	8470TCPSH0212	64mm	8470TCPSH0434	121mm
8470TCPSH0116	27mm	8470TCPSH0296	65mm	8470TCPSH0500	127mm
8470TCPSH0118	29mm	8470TCPSH0258	67mm	8470TCPSH0514	133mm
8470TCPSH0136	30mm	8470TCPSH68MM	68mm	8470TCPSH0512	140mm
8470TCPSH0156	33mm	8470TCPSH0234	70mm	8470TCPSH0600	152mm
8470TCPSH0138	35mm	8470TCPSH0278	73mm	8470TCPSH160MM	160mm
8470TCPSH0176	37mm	8470TCPSH0300	76mm	8470TCPSH168MM	168mm
8470TCPSH0196	40mm	8470TCPSH0318	79mm	8470TCPSH177MM	177mm
8470TCPSH0158	41mm	8470TCPSH0314	83mm	8470TCPSH210MM	210mm
8470TCPSH1116	43mm	8470TCPSH0338	86mm		

Starrett Holesaws

Smooth cut with minimal tendency to bite or snag when cutting thinner gauge materials



The complete multi purpose saw. Dual pitch professional saws will cut a wide range of materials, irrespective of thickness

Cutting depth 41mm

Starrett dual pitch professional hole saws are the largest development in multi use bi-metal holesaws. Featuring the smooth cutting action of constant pitch holesaws, combined with aggressive material penetration and swarf clearance, Dual pitch professional holesaws will cut equally well on thin and thicker gauge materials.

Code	Size
8470TSH0096	14mm
8470TSH0058	16mm
8470TSH1016	17mm
8470TSH0034	19mm
8470TSH252	20mm
8470TSH1036	21mm
8470TSH0078	22mm
8470TSH1056	24mm
8470TSH0100	25mm
8470TSH0116	27mm
8470TSH0118	29mm
8470TSH0136	30mm

Fits arbors A1, A4, A11

Code	Size
8470TSH0196	40mm
8470TSH0158	41mm
8470TSH1116	43mm
8470TSH0134	44mm
8470TSH1136	46mm
8470TSH0178	48mm
8470TSH0200	51mm
8470TSH0216	52mm
8470TSH0218	54mm
8470TSH0214	57mm
8470TSH0256	59mm
8470TSH0238	60mm

Fits arbors A2, A3, A6

Code	Size
8470TSH0114	32mm
8470TSH0156	33mm
8470TSH0138	35mm
8470TSH0176	37mm
8470TSH0112	38mm

Fits arbors A1, A2, A3, A4, A6, A11



Code	Size
8470TSH0212	64mm
8470TSH0296	65mm
8470TSH0258	67mm
8470TSH68MM	68mm
8470TSH0234	70mm
8470TSH0278	73mm
8470TSH0300	76mm
8470TSH0318	79mm
8470TSH0314	83mm
8470TSH0338	86mm
8470TSH0312	89mm
8470TSH0358	92mm
8470TSH0334	95mm
8470TSH0378	98mm
8470TSH0400	102mm
8470TSH0418	105mm
8470TSH0414	108mm
8470TSH0438	111mm
8470TSH0412	114mm
8470TSH0434	121mm
8470TSH0500	127mm
8470TSH0514	133mm
8470TSH0512	140mm
8470TSH0600	152mm
8470TSH160MM	160mm
8470TSH168MM	168mm
8470TSH177MM	177mm
8470TSH210MM	210mm

Fits arbors A2, A3, A6

HOLESAWS



Morse Holesaws

Backer, cutting edge and cap work together to provide faster, longer-lasting cutting action

Bi-metal design bonds M3 cutting edge to fatigue resistant backer



Positive rake teeth clear chips better for longer life and easier cutting

Teeth stay sharper and make smoother cuts

Professional quality holesaws feature an M3 high-speed steel cutting edge, electron beam welded to a tough steel backer. Caps stand up to abuse and punishment, yet are light and easy to use. Positive rake tooth design provides better chip clearance as teeth cut into wood, plastic or any machinable metal. A separate arbor is required.

Code	Size
4501T019	14mm
4501T020	16mm
4501T021	17mm
4501T022	19mm
4501T64	20mm
4501T023	21mm
4501T024	22mm
4501T025	24mm
4501T67	25mm
4501T105	27mm
4501T109	29mm
4501T69	30mm

Fits arbors M24, M24K, M34, M44, M44K

Code	Size
4501T119	40mm
4501T120	41mm
4501T121	43mm
4501T122	44mm
4501T123	46mm
4501T124	48mm
4501T200	51mm
4501T205	52mm
4501T209	54mm
4501T214	57mm
4501T215	59mm
4501T216	60mm

Fits arbors M35PS, M44K, M45, M45P, M55P

Code	Size
4501T218	64mm
4501T219	65mm
4501T220	67mm
4501T779	68mm
4501T222	70mm
4501T224	73mm
4501T300	76mm
4501T309	79mm
4501T314	83mm
4501T316	86mm
4501T318	89mm
4501T320	92mm
4501T322	95mm
4501T324	98mm
4501T400	102mm
4501T409	105mm
4501T414	108mm
4501T416	111mm
4501T418	114mm
4501T422	121mm
4501T500	127mm
4501T514	133mm
4501T518	140mm
4501T600	152mm

Fits arbors M35PS, M44K, M45P, M55P

Code	Size
4501T114	32mm
4501T115	33mm

Fits all arbors

Code	Size
4501T116	35mm
4501T117	37mm
4501T118	38mm

Fits all arbors (except M24)



H&C Code	Shank Size
4502TM24K	1/4 Round
4502TM24	1/4 Hex
4502TM34	3/8 Hex
4502TM44K	7/16 Hex
4502TM44	7/16 Hex
4502TM35PS	3/8 Hex
4502TM45	7/16 Hex
4502TM45P	7/16 Hex
4502TM55P	7/16 Hex

Stanley 99E Original Retractable Blade Knife

Code: 2535T210099

Precision die cast zinc body both strong and lightweight

The one and only original Stanley retractable knife

Interlock nose firmly secures blade into knife

Blades stored inside the handle

5 blade positions allows wider usage for variety of cutting applications



Stanley Lightweight Retractable Knife

- Lightweight, tough ABS plastic body
- Interlocking jaw feature
- Supplied with 2 heavy duty blades

Code: 2535T010088



Stanley Spring Back Knife

- The blade remains outside as long as a thumb is kept on the push button and retracts automatically when the button is released

Code: 2535T110089



Stanley Xtreme Twin Blade Knife

- Instant blade change button
- Swing out blade storage for 5 blades
- Safety interlock
- Bigger than standard Utility knives allowing work with gloved hands

Code: 2535T010789



Stanley Retractable Titan Knife

- Heavy duty aluminium body with overlapping nose
- Brass wheel for changing and positioning
- Supplied with 3 blades

Code: 2535T210122



Stanley Fatmax Xtreme Retractable Blade Knife

- Die cast aluminium housing
- Supplied with 10 spare blades
- Magnetic nose
- Brass wheel blade lock

Code: 2500T510819



Stanley Fatmax Retractable Folding Knife

- Folding lockback design
- Retractable blade
- Rubberised thumb pad
- Instant blade change

Code: 2551T010825



Stanley Dynagrip Retractable Blade Knife

- Precision die cast zinc body
- 3 blade positions
- Interlock nose
- Blades stored inside the handle

Code: 2535T010707



Stanley Quickslide Pocket Utility Knife

- No tools required to change blade
- One handed operation blade slider
- Push down and slide safety feature
- Pocket size

Code: 2535T510810



KNIVES & BLADES



Stanley Instant Change Retractable Blade Knife

- Cast zinc body
- Improved blade change
- Increased blade storage
- Large thumb pad

Code: 2500T198456



Hardman Metal Fixed Utility Knife

- Includes 3 blades

Code: AT17017



Stanley 199E Fixed Blade Knife

- Zinc alloy body with a knurled surface
- Overlapping nose blade locking system
- Knife supplied with an assortment of 3 blades

Code: 2536T210199



Stanley Fixed Blade Utility Knife

- Metal knife lacquered and grooved for improved holding
- Supplied with 3 spare blades

Code: 2500T010299



Stanley Fatmax Xtreme Fixed Blade Knife

- Supplied with 10 heavy duty blades
- Holds up to 15 blades
- Die cast aluminium housing
- No tools required for blade changing

Code: 2500T510818



Stanley Titan Blade Knife

- Lightweight aluminium body
- Strong high quality brass wheel
- Ideal for precision cutting
- Supplied with 3 heavy duty blades

Code: 2535T010550

With Scabbard - Code: 2535T110550

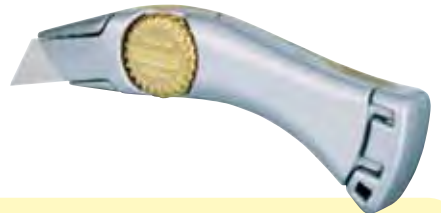

Stanley SM Snap-Off Blade Knife

- Two part moulded body that allows rapid blade changing
- Multi position push button for quick, easy use
- Blade snapper included in handle for safety

9mm - Code: 2550T55
18mm - Code: 2550T63



Stanley Fatmax Xtreme Snap-Off Cartridge Blade Knife

- Locking knob ideal for heavy duty applications
- Die Cast aluminium housing
- Stainless steel cartridge holds 4 blades
- No tools required for blade changing

Code: 2500T510820



Stanley Fatmax Snap-Off Cartridge Blade Knife

- Blade wiper
- Blade locking clamp
- Auto loading spare blade
- Soft grip bi-material handle
- Blade snapper

9mm - Code: 2551T010475
18mm - Code: 2551T010481
25mm - Code: 2551T010486



Hardman Quick Change Utility Knife

- Spring loaded blade chamber
- Integrated wire stripper
- Durable lightweight aluminium body
- Soft grip

Code: AT17015



Stanley Folding Pocket Knife

- Pocket craft knife with folding blade
- Metal body for strength

110mm - Code: 2554T010598



Stanley Disposable Craft Knife

- For precision work
- A tapered plastic body allows precision blade control
- Blades protected by plastic guard
- Supplied with 5901 blade

Card of 3 - Code: 2554T010601
Box of 50 - Code: 2554T110601





KNIVES & BLADES

Stanley Sport Utility Quickslide Knife

- 3" serrated sport blade
- Standard utility blade
- No tools required for blade changing
- One handed operation blade slider

Card of 2 - **Code: 2535T910813**



Stanley Skeleton Liner Lock Knife

- Stainless Steel rust free and durable
- Thumb knob for easy opening
- Liner lock strong positive locking action

Carded - **Code: 2554T510253**



Hardman Spring Back Knife

- Safety spring back feature
- Push blade forward to use blade
- Blade automatically retracts when blade button released

Carded - **Code: AT17014**



Irwin Protouch X Retractable Knife

- Lightweight
- Durable
- Stores 10 blades
- Quick change blade mechanism

Code: 3820T10508104



Irwin General Construction Retractable Knife

- Lightweight & durable retractable knife
- Push & slide opening mechanism provides easy tool-free blade access
- Solid & durable knife with secure parts
- Trigger grip enables the user to easily cut on the pull

Code: 3820T10508105



Irwin Drywaller Fixed Knife

- Specially made for working in dusty conditions
- Robust and lightweight
- Can be stored on a tool belt
- 1/2-turn thumb screw for tool-free access

Code: 3820T10508103



Irwin Fixed Carpet Knife

- Angled handle is designed to keep the hand above the cutting material for optimal comfort and security
- The knife is used with a special carpet blade
- Thumbscrew provides tool-free access to quickly change blades

Code: 3820T10508106



Bahco Utility Knife KB-Series

- Full aluminium body with comfortable TPE grip
- Integrated button to avoid accidental opening
- Option at back of the knife to secure safety strap
- Both in fixed and retractable versions

Fixed Blade - **Code: 6160TKBFU01**

Retractable Blade - **Code: 6160TKBRU01**



Irwin Carbon Steel Carpet Blades

- The blade rigidity ensures straight cuts in carpet

5 Pk - **Code: 3820T10508111**



Bahco Sports Utility Knives

- Stainless steel blade and mechanism
- Blade locks in position when fully unfolded
- Unlock button to avoid accidental folding

3" Sports Knife - **Code: 6160TKBSK01**

Sports Lockback Knife - **Code: 6160TKBSU01**

Twin Blade Knife - **Code: 6160TKBTU01**



Bahco Ergo Utility Knife

- Integrated button for smooth action and to shift blade in three distinct positions
- Curved handle for wide variety of grips
- Narrow head for optimal visibility and precision
- Optimized handle size and weight

Fixed Blade - **Code: 6160TKEFU01**

Retractable Blade - **Code: 6160TKERU01**

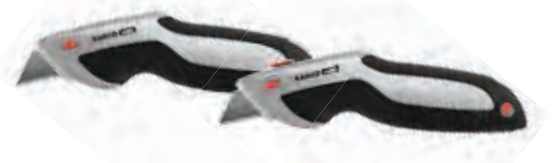

KNIVES & BLADES



Stanley Fatmax Blade

- Heavy duty general purpose blade
- Up to 35% sharper
- Up to 20% stronger
- Up to 75% longer life
- Snap resistant to 35kg
- Thickness of blade 0.61mm

Pack of 10 - **Code: 2537T611700**



Stanley 1992 Heavy Duty Blade

- The original heavy duty general purpose blade
- Blades fit all standard Stanley knives
- Ideal for carpet vinyl and any other material requiring a stiffer stronger blade

Dispenser of 10 - **Code: 2537T611921**
 Card of 5 - **Code: 2537T011921**
 Carded dispenser of 10 - **Code: 2537T211921**
 Loose box of 100 - **Code: 2537T111921**
 Loose box of 400 - **Code: 2537T411921**



Irwin Bi-metal Blue Trapezoid Blades

- Shatterproof
- Durable last 3x longer
- Outlasts and outperforms traditional carbon blades

10 x 10pk
Code: 3820T10504241



Stanley 1991 Trimming Knife Blade

- Heavy duty general purpose blade
- Blades fit all standard Stanley knives (except 99E)

Card of 5
Code: 2538T011911
 Carded dispenser of 10
Code: 2538T611911
 Loose box of 100
Code: 2538T111911



Irwin Carbon Steel 4 Point Trapezoid Blade

- Scored edges give 4 sharp points which doubles the life of the blade
- The 4 notches enable the blade to be extended to maintain blade length after snapping off sections

5 Pk - **Code: 3820T10508107**
 10 Pk - **Code: 3820T10508108**
 100 Pk - **Code: 3820T10508109**



Stanley 9mm Snap Off Knife Blades

- Spare blade dispenser
- 12 breakable blade segments

Card of 5 - **Code: 2552T211300**
 Loose box of 100 - **Code: 2552T111300**



Stanley 18mm Snap Off Knife Blades

- Spare Blade Dispenser
- 7 breakable blade segments

Card of 5 - **Code: 2500T211301**
 Box of 100 - **Code: 2552T111301**



Stanley 25mm Snap Off Knife Blades

- Spare Blade Dispenser
- Reinforced thickness
- 6 breakable blade segments

Card of 10 - **Code: 2537T011325**

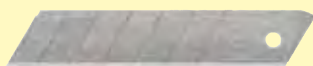

Stanley Fatmax 18mm Snap Off Blades

- Best ever Stanley blade with patented induction hardened edge
- Up to 25% longer life

Card of 5 - **Code: 2537T511700**



Stanley Fatmax 25mm Snap Off Blades

- Best ever Stanley blade with patented induction hardened edge
- Up to 50% longer life

Card of 5 - **Code: 2537T511725**



Stanley 1996 Hooked Trimming Knife Blade

- Sharpened Hook Blade with point
- Blades fit all Stanley knives

Card of 5
Code: 2539T011983
 Loose box of 100
Code: 2539T111983



Stanley 5901 Slimknife Blade

- Straight general purpose light duty blade for modelling and craft work
- For use with 10-590 craft knife

Card of 3
Code: 2555T011221
 Loose box of 50
Code: 2555T111221



Stanley Saw Blades To Fit Fixed Blade Knives

- For use in restricted areas or for curved shapes
- For use with Stanley fixed blade knives

For Wood
Code: 2546T015276
 For Metal
Code: 2546T015277



Stanley Concave 5192 Knife Blade

Card of 5
Code: 2542T011952

Loose box of 100
Code: 2542T111952



British Heavy Duty Knife Blade

- Fits Hardman and other retractable knife brands

Box of 100 - **Code: 7751TBLADE**



Hardman Replacement Blade Dispenser

- Suitable for Hardman and other utility knives
- Made in UK

Code: AT17016





KNIVES & BLADES

Eclipse Piercing Saw - PS51

- Piercing saw for use in fine metal work such as jewellery and dentistry
- Comfortable wooden handle and steel frame

Saw - Code: 3904TPS51



Eclipse Piercing Saw Blades

Code	Size	Teeth Per Inch
3905T050080	125mm (5")	80
3905T050060	125mm (5")	60
3905T050052	125mm (5")	52
3905T050044	125mm (5")	44
3905T050032P	125mm (5")	32



Hardman Jigsaw Blades By MPS

- Sold in packs of 5



Code	Description	Bosch Part Number
ATJIG3111	Jigsaw Blade Basic For Metal	T118A
ATJIG3101	Jigsaw Blade Wood Clean Cut	T101B
ATJIG3102	Jigsaw Blade Wood Down Cut	T101BR
ATJIG3104	Jigsaw Blade Speed For Wood	T144D
ATJIG3103	Jigsaw Blade Wood Clean Cut	T101D
ATJIG3114	Jigsaw Blade Basic For Metal	T318A
ATJIG3171	Jigsaw Blade Wood Clean Cut	T101AO
ATJIG3106	Jigsaw Blade Wood Fast Cut	T111C
ATJIG3113	Jigsaw Blade Basic For Metal	T118B
ATJIG3118	Jigsaw Blade Special For Aluminium	T127D
ATJIG3406	Jigsaw Blade Fast Coarse Cut	B&D fitment
ATJIG3411	Jigsaw Blade Straight Cut In Metal	B&D fitment
ATJIG3101KR	Jigsaw Blade For Curve Cutting	Unique special application
ATJIG3160	Jigsaw Blade Splinter Free Clean Cut	Unique special application
ATJIG3150F	Jigsaw Blade Universal Blade	Unique special application

Stand available ask your local representative for details
- ATJIGSAWDISP

LASER LEVELS



Leica Lino L2 Cross Line Laser

- Range of up to 15m (depending on light conditions)
- Levelling accuracy of +/- 1mm @ 5mm
- Self-levelling range 4° +/- 0.5°
- Horizontal accuracy +/- 1mm @ 5m
- Vertical accuracy +/- 0.75mm @ 3m line length
- Laser type 635nm, laser class II



Code: 9992TL2

Leica Runner 20 Optical Level Kit

- Robust and accurate
- Air-damped compensator
- Water resistant (IP55)
- Double-sided endless fine drive
- Pentaprism for easy viewing of circular level
- Horizontal circle with 360° division
- Budget-priced

Code: 9992RUNNER20K

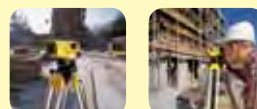

Stanley AL24 Auto Level Kit

- Range of 90m
- 24 x automatic optical level
- Levelling accuracy of +/- 1.6mm @ 50m
- 3 screw levelling setting viewed via angular prism
- Magnetically dampened, wire hung compensator
- Top optical peep sight for ease of ranging
- Right angle prism for easy bubble viewing
- Objective aperture 40mm
- 1:100 stadia for estimating distance
- Compensator lock protects unit in transit
- Fine motion knobs for easy horizontal movement
- Rated to IP54 to protect against dust and water splashes
- 5 year warranty

Code: 2500T177159



Kit Includes
Level, plumb bob, lens cover, hex key 7 adjustment pin, manual, hard protective carry case, tripod and measuring staff



Stanley Laser Glasses

- Laser glasses designed to enhance the brightness of the laser line internally and externally

Code: 2500T177171

Stanley Fatmax CLLi Cross Line Laser Kit

- 10m range
- 0.4mm/m accuracy
- Projects 1 horizontal and 1 vertical line to create a cross line
- Out of true level sensor
- Self levelling
- Runs on 3 x AA batteries (supplied)
- Pendulum lock for safe transportation
- Rated to IP54 to protect against dust and water splashes
- 1 year warranty

Code: 2500T177117



Kit Includes
Tri-pod, laser, grid target, carry case, 3 x AA batteries, camera tripod 1.5m & pole mounting bracket



Stanley Fatmax CL2i Cross Line Laser

- 15m range
- 0.3mm/m accuracy
- Projects 1 horizontal and 1 vertical line to create a cross line
- Pulsed beam mode allows operation outdoors in combination with the detector (177023)
- Out of true level sensor
- Self levelling
- Runs on 3 x AA batteries (supplied)
- Pendulum lock for safe transportation
- Rated to IP54 to protect against dust and water splashes
- 1 year warranty

Code: 2500T177120



Kit Includes
Laser grid target, carry case, 3 x AA batteries & mini tripod



Agatec CL30 Cross + Line Laser

- Self-levelling cross line laser
- Four line options, including 130° vertical
- Locked line angle mode to match an angle between two points
- Protective rubber housing

Code: AGACL30



Agatec CPL50 Cross + Line Laser

- Cross line laser with floor-to-ceiling plumb beam
- Self-levelling
- Locked line angle mode to match an angle between two points
- Pendulum lock for safe transport
- Mounting bracket for wall layout
- Can use with optional detector outdoors

Code: AGACPL50



Agatec PL5 Cross Line Laser c/w Adaptor

- 5 point horizontal and plumb laser level
- Self-levelling
- High visibility beams
- Fastest self-levelling laser
- Accurate to the millimeter: (+/- 1mm)
- With dedicated adaptor, especially designed for drywall track and floor to ceiling plumbing

Code: AGAPL5



Full range of Hammers available from page 49

STANLEY
FatMax

Hardman
WORK TOUGH TOOLS

Estwing



LEVELS

Stanley Fatmax Xtreme

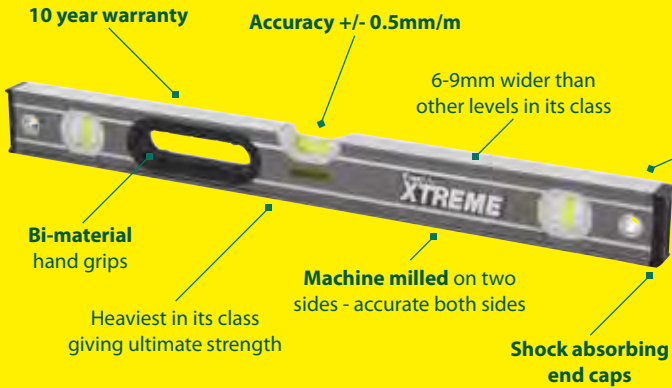

STANLEY

Code	Size
2500T043616	400mm
2500T043624	600mm
2500T043636	900mm
2500T043640	1000mm
2500T043648	1200mm
2500T043672	1800mm
2500T043681	2000mm
2500T543625	600mm Magnetic Level
2500T543649	1200mm Magnetic Level

Code	Size	Code	Size
2500T143553	600mm	2500T143554	600mm - Magnetic
2500T143555	1200mm	2500T143556	1200mm - Magnetic
2500T143557	1800mm	2500T143558	2000mm - Magnetic

Stanley Fatmax I-Beam

- 0.5mm/m accuracy to ensure accurate levelling for a professional finish
- Stronger than a Stanley II box level for longevity and heavy duty use
- Rubber end caps protect the level against damage if dropped
- Curved body profile allows the level to be used for gradients on drainage and pipework



Stanley 2

- Machined on bottom surface for maximum accuracy (up to 1200mm level)
- Ribbed tubular section aluminium body for strength & rigidity
- Solid block vials guaranteed against breakage and leakage for 5 years. 4 vials over 1500mm
- Easy to clean epoxy finish for long life
- Accuracy +/- 0.5mm/m

Code	Size
2783T2400	600mm
2783T3600	900mm
2783T4000	1000mm
2783T4800	1200mm
2783T5900	1500mm
2783T7000	1800mm
2783T8000	2000mm



Stanley Fatmax

- 6mm taller than most competitors
- 6-9mm wider than other levels in its class
- Heaviest in its class giving ultimate strength
- Shock absorbing end caps for long life
- Machine milled on two sides accurate both sides
- Dual bi-material hand grips ideal for carrying & vertical levelling
- Improved vial view for ease of use
- Large vial with bridged "dual view" centre vial
- 5 year guarantee for warranty

Code	Size
2501T543524	600mm
2501T543536	900mm
2501T543548	1200mm
2501T543572	1800mm
2501T543525	600mm Magnetic Level
2501T543537	900mm Magnetic Level
2501T543549	1200mm Magnetic Level

Hardman Maxi 3 Vial Level

- 600mm - Code: **AT12011**
- 800mm - Code: **AT12012**
- 1000mm - Code: **AT12013**
- 1200mm - Code: **AT12014**
- 1800mm - Code: **AT12015**

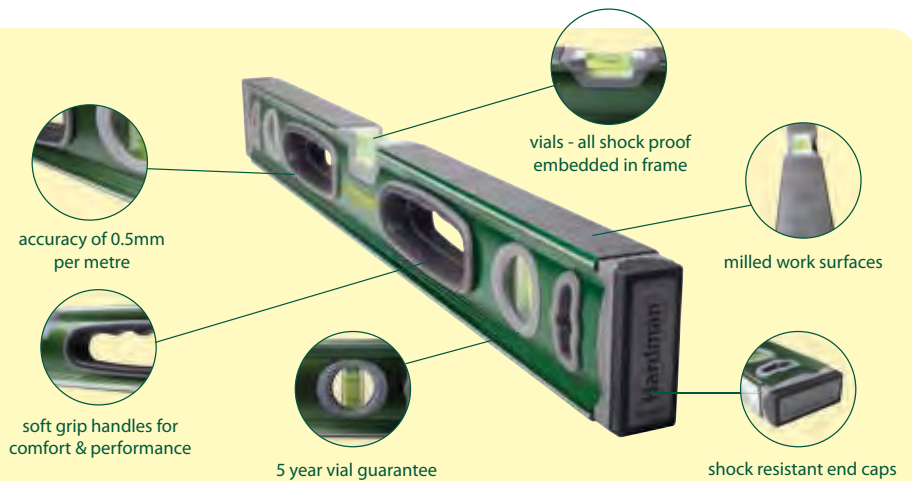

Bahco 466 Spirit Level

- Machined surface on top and bottom
- Anti-shock rubber end caps
- Laser edged centre zero measuring scale along the edge
- Anodised finish
- 2 hand holes



Code	Size
6201T4660600	24"/600mm
6201T4661200	48"/1200mm
6201T4661800	72"/1800mm
6201T4662000	80"/2000mm

Bosch Angle Measure & Mitre Finder

- Automatic calculations of single and double mitre angles
- Pivoting measuring arm
- Two levelling vials
- Built-in cornice angle cutting calculator
- Extension piece for measuring accurate angles
- Clear digital readouts
- Length 400m
- Measurement range 0-220°
- Dimensions 432 x 35 x 61mm
- Calculated angle accuracy
- Spirit level +/- 0.05°



Code: **BTGAM220MF**

Stabila 83S Series

- 2 milled measuring surfaces
- Robust and very practical
- It's 2 handholds make it very comfortable to use
- 3 vials
- Accuracy +/- 0.5mm/m

- 40cm - Code: **4205T1600**
- 60cm - Code: **4205T2400**
- 80cm - Code: **4205T3200**
- 100cm - Code: **4205T4000**

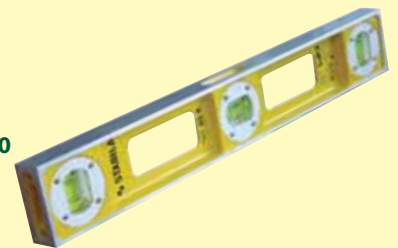

Stabila 96-2

- Extra strong, light metal
- Gripping ridges
- Removable end caps made from two materials
- 2 milled measuring surfaces
- 2 vertical vials and 1 horizontal vial
- Measurement accuracy 0.029° = 0.5mm/m



Code	Size
4204T96216	40cm
4204T96224	60cm
4204T96232	80cm
4204T96240	100cm
4204T96248	120cm
4204T96272	180cm
4204T96278	200cm
4204T96296	244cm

LEVELS

STANLEY

Hardman
WORK TOUGH TOOLS

STABILA  with stoploads

Stanley Fatmax Xtreme 250mm Torpedo Level

- 250mm/10" Aluminium die-cast body
- 0.5mm/m accuracy
- Two magnets in the base ideal for erecting scaffolding
- Pipe groove provides maximum adherence to rounded surfaces
- 5 year accuracy guarantee

Code: 2500T043603



Stanley Fatmax Xtreme 250mm Torpedo Level - Magnetic

- Solid block vials provide best in class accuracy 0.5mm/m
- Magnified centre vial for improved all round visibility
- Rotating vial
- Rare earth magnets which are twice as strong as basic strip magnets
- V shaped metal groove for use on pipes

Code: 2500T543609



Stanley Shockproof Torpedo

- High visibility vials horizontal, vertical and 45°
- Rubber end caps to provide protection
- 230mm level

Code: 2500T043510

Magnetic - **Code: 2500T043511**



Stanley 9" Aluminium Torpedo

- Strong & lightweight aluminium body ideal for small installations
- Magnetic base ideal for steel construction
- 3 vials; horizontal, vertical and 45°
- Protected centre vial for resistance to shocks
- 230mm level

Code: 2519T0900



Stanley 8" Plastic Torpedo

- Lightweight injection moulded ABS body for strength
- 3 tubular vials; horizontal, vertical and 45°

Code: 2519T0800



Stabila 10" 2 Vial Boat

- Made from pressure-cast light metal
- Slim bevelled shape suitable for working in tight spaces
- Milled measuring face

815 - Code: 4207T1000

815M - Magnetic - Code: 4208T1000



Hardman Boat Level Pack c/w Line Level

Boat Level

- Durable construction
- 3 vials: horizontal, plumb and 45°
- Rubber shock proof end caps
- Aluminium work surfaces
- Base groove allows work in plumbing and pipe work applications



Line Level

- Aluminium construction
- For use in conjunction with stringline for brickwork and setting out



Code: AT12000

Stanley 3 1/4" Line Level

- Useful for setting out levels over large areas where precision is of secondary importance e.g ideal for landscape gardening
- Includes hooks for using on a line
- Lightweight metal body for long life
- 80mm

Code: 2521T0314



Irwin Vise Grip - Straight Jaw

175mm - Code: **4631T0700C**

250mm - Code: **4631T1000C**

175mm Fast Release - Code: **4631TT03T**

250mm Fast Release - Code: **4631TT01T**

Heavy duty jaws allow for maximum contact on all work shape flat or square

Popular in welding and other metal work

Used for safer grinding or as a portable vice

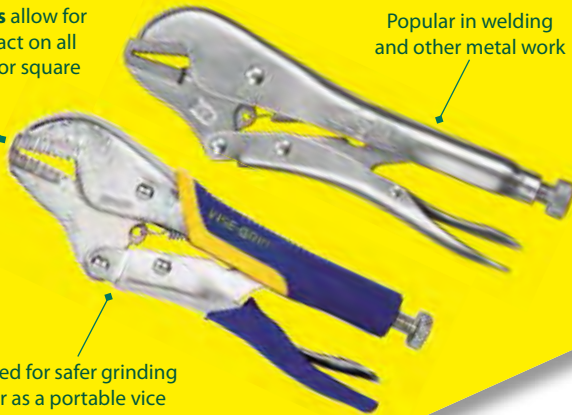

LOCKING PLIERS

Irwin Vise Grip

Original locking tools, with a classic trigger release, are designed to provide maximum locking force.



Irwin Vise Grip Fast Release

Fast release locking pliers have a one-handed, triggerless release, so they're twice as easy to open as the traditional design. Anti-pinch, non-slip ProTouch Grips provide comfort, control, and less hand fatigue.



Irwin Vise Grip - Locking Plier Sets

- IRWIN Vise-Grip locking pliers are made of high-grade alloy steels
- Heat treated for maximum toughness and durability
- Each tool is treated with a bright nickel-plated surface for an attractive, corrosion resistant finish

Code	Size
4633TT77T	2Pce Fast Release Plier Set
4633TT214T	2Pce Fast Release Plier Set
4633TT76KBT	3Pce Fast Release Kitbag Set

Irwin Vise Grip - Curved Jaw

- Designed for gripping circular objects
- Ideal for plumbing and general pipe work
- Wire cutter suitable for cutting wire, screws and bolts up to 6mm



Code	Size
4632T0400	100mm Curved Jaw Locking Plier - 4WRC
4632T0500	125mm Curved Jaw Locking Plier - 5WRC
4632T0700	175mm Curved Jaw Locking Plier - 7WR
4632T1000C	250mm Curved Jaw Locking Plier - 10WRC
4633TT10T	125mm Fast Release
4633TT13T	175mm Fast Release
4633TT11T	250mm Fast Release
4633TT09T	125mm Fast Release - w/Cutter
4633TT07T	175mm Fast Release - w/Cutter
4633TT05T	250mm Fast Release - w/Cutter

LOCKING PLIERS



Irwin Vise Grip - Long Nose

- The long tapered nose plier is ideal for delicate work, hobbies, tight spaces, electronics and clamping of small parts
- The long nose plier features a built in wire cutter which in progressive bits cuts up to 1/4" bolt



Code	Size
4634T0400	100mm Locking Pliers - c/w Cutter
4632T0600	150mm Locking Pliers - c/w Cutter
4632T0900	225mm Locking Pliers - c/w Cutter
4634TT14T	150mm Fast Release
4634TT15T	225mm Fast Release

Irwin Vise Grip - C Clamps

- Wide opening jaws provide the user greater versatility in clamping project than otherwise available in old fashioned clamps
- Popular in welding, autobody repair and other metal work



Code	Size
4636T0600	150mm Locking C Clamps
4636T1100	275mm Locking C Clamps
4636T1800	450mm Locking C Clamps
4633T10507190	150mm Quick Release
4633T10507189	275mm Quick Release

Irwin Vise Grip - Clamps

- Wide opening jaws with swivel pads hold tapered work open fabricating jobs and delicate projects
- Popular in autobody repair and other work on delicate or odd shape surfaces



Code	Size
4641T0400	100mm Locking Clamps c/w Swivel Pads
4641T0600	150mm Locking Clamps c/w Swivel Pads
4641T1100	275mm Locking Clamps c/w Swivel Pads
4641T1800	455mm Locking Clamps c/w Swivel Pads
4641T2400	600mm Locking Clamps c/w Swivel Pads

Irwin Vise Grip - Welding Clamps

- Designed to hold varying thickness of materials in proper alignment

Code	Size
4638T0900	225mm Locking Welding Clamp - 9R



Irwin Vise Grip - Large Jaw Locking Pliers

- Large jaws and clamping ability make this tool ideal for plumber, mechanics, welders and others that work with large objects
- Convenient size makes it easier to use than bulkier tools such as pipe wrenches
- Opens up to 3 1/8"/79mm diameter

Code	Size
4630T1200	300mm Locking Pliers - 12LC



Irwin Vise Grip - Sheet Metal Tool

- Locks to work with powerful grip
- Designed to increase efficiency whilst bending, forming, and crimping tools

Code	Size
4637T0800	200mm Locking Sheet Metal Tool - 8R



Irwin Vise Grip - Locking Chain Clamp

- Designed to hold odd shapes for welding and fabrication and to adjust quickly for ratchet action in either direction
- Also suitable for removal of components difficult to remove with conventional tools

Code	Size
4640T0900	225mm Locking Chain Clamp - 20R



LOCKING PLIERS



Stanley Curved Jaw Mole Grip

- Curved jaw ideal for pipes or hexagonal nuts
- Built in wire cutter for convenience
- Forged and machined jaws for maximum durability
- Non-pinching 'pull' jaw release improves safety and ease of opening
- Screws adjust the jaws and the amount of clamping pressure for precision work
- Chrome plating is corrosion resistant for long life



Code	Size
2751T084807	145mm/6"
2751T084808	185mm/7"
2751T084809	225mm/9"

Hardman 3 Piece Locking Plier Set

- 6.5" long nose plier
- 7" & 10" normal locking plier

Code: AT86600



Hardman Pliers & Clamps

- Professional quality
- Hardened chrome vanadium jaws
- Chrome molybdenum handle
- Fully guaranteed

Code	Description	Size
AT86700	Curve Jaw with Wire Cut Locking	5"
AT86701	Curve Jaw Locking Plier	7"
AT86702	Curve Jaw with Wire Cut Locking	7"
AT86703	Curve Jaw Locking Plier	10"
AT86704	Curve Jaw with Wire Cut Locking	10"
AT86705	Straight Jaw Locking Plier	7"
AT86706	Straight Jaw Locking Plier	10"
AT86707	Needle Nose Locking Plier	6"
AT86708	Sheet Metal Grip Locking Plier	8"
AT86709	Fork Jaw Locking Plier	9"
AT86710	C Clamp	6"
AT86711	C Clamp	11"
AT86712	C Clamp	18"
AT86713	C Clamp with Swivel Tips	11"
AT86714	C Clamp with Swivel Tips	6"



Rocol Dry Moly Spray

- Dry film lubricant
- Does not collect dust & dirt
- Suitable for small gears & bearings

400ml Can - **Code: 7450T10025**



Rocol Dry Moly Paste

- Dry film lubricant
- Provides excellent load carrying
- Prevents galling, pick up and seizure

100g Tube - **Code: 7450T10040**

750g Tin - **Code: 7450T10046**



Rocol Anti Seize Spray

- Copper based - lead free formulation
- Excellent water resistance
- Use on all threaded and static fasteners

400ml Can - **Code: 7452T14011**



Rocol Anti Seize Compound

- Copper based - lead free formulation
- Resistant to water and sea water
- Can be used sub sea

85g Tub - **Code: 7452T14030**

500g Tub - **Code: 7452T14033**



Rocol Belt Dressing Spray

- Conditions drive and conveyor belts
- Prevents glazing and cracking
- Reduces slipping

300ml Can - **Code: 7460T34295**



Rocol Chain & Drive Spray

- General purpose drive and conveyor chain lubricants
- Ideal for humid conditions
- Water repellent to increase lubrication

300ml Can - **Code: 7456T22001**



Rocol Heavy Duty Chain Spray

- Moly formulation for high loads
- Suitable for drive and conveyor chains
- Excellent protection

300ml Can - **Code: 7456T22141**



Rocol Electra Clean Spray

- Powerful cleaner for electrical equipment
- Compatible with most plastics
- Total evaporation - residue free

300ml Can - **Code: 7460T34066**



Rocol Heavy Duty Cleaner Spray & Fluid

- Emulsifies the oil grease to allow removal by hosing or wiping
- Safe on metal, paint and most plastics
- Free form chlorinated solvents
- A powerful slow evaporating, water emulsifiable solvent based cleaner suitable for use in most general industrial environments

300ml Can - **Code: 7460T34011**



Rocol Industrial Cleaner Rapid Dry Spray

- Extremely powerful solvent
- Fast evaporation leaves no residue
- Safe on metal, most plastics and paints

300ml Can - **Code: 7460T34131**



Rocol Foam Cleaner Spray

- Cuts through dirt & grease fast
- Ideal for non-porous surfaces

400ml Can - **Code: 7460T34145**



Rocol Foodlube Sugar Dissolving Fluid

- Food grade spray to dissolve and remove sugars and fondants from all surfaces leaving a light lubricating protective film
- Rapid penetrating action
- Protects against corrosion
- Temperature range -50°C to +180°C
- NSF H1 Registered

500ml Bottle - **Code: 7453T15110**



Rocol Foodlube WD Spray

- Food grade water displacing & lubricating spray with PTFE
- The No1 food safe multi-purpose spray for general use in food, beverage and pharmaceutical plants
- Clean, non-toxic, water displacing spray
- PTFE fortified
- Silicone free formulation
- Excellent anti-wear and lubricating properties
- Superior penetrating and cleaning performance
- Outstanding corrosion protection
- Temperature range -50°C to +120°C
- NSF H1 Registered

300ml Can - **Code: 7453T151010**



Rocol Foodlube Multi-Lube Fluid

- Food grade, multi purpose lubricant fortified with PTFE for effective lubrication particularly on chains, bearing and slides
- Clean non-toxic thin film aids fast penetration
- Good load carrying properties
- Excellent corrosion protection
- Temperature range -50°C to +180°C
- NSF H1 Registered



500ml Bottle - **Code: 7453T15120**

Rocol Foodlube Universal

- High performance, multi purpose, food grade bearing grease for maximum life
- A truly universal extreme pressure bearing grease, fortified with PTFE, designed for the enhanced lubrication of all types of ball, roller and plain bearings
- Significantly extends bearing life
- Superior load and wear properties
- Highly resistant to water washout
- Excellent corrosion protection
- Temperature range -50°C to +160°C
- NSF H1 Registered



380g Tube - **Code: 7453T15201**

Rocol Foodlube Chain Spray

- Tenacious, food grade spray lubricant for maximum chain life
- Outstanding penetration properties
- Highly resistant to water wash off
- Good water displacing properties
- Tenacious low drip formulation
- Good load carrying capacity
- Temperature range -20°C to +110°C
- NSF H1 Registered



400ml Can - **Code: 7453T15610**

Rocol Foodlube Spray

- High performance, aerosol propelled food grade lubricant
- High performance versatile lubricant spray for all round light lubrication of small bearings, pins, bushes and slides
- Long lasting protective film
- Good corrosion protection
- Temperature range -20°C to +110°C
- NSF H1 Registered



300ml Can - **Code: 7453T15710**

Rocol Foodlube Dismantling Spray

- A fast acting penetrating spray for the fast and effective release of corroded and seized components
- Highly efficient penetration
- Short term corrosion protection for released parts
- Temperature range -20°C to +110°C
- NSF H1 Registered



300ml Can - **Code: 7453T15720**

Rocol Foodlube Universal Unilube

- New and improved food grade grease dispenser for continuous lubrication
- A gas activated lubricant dispenser filled with Foodlube Universal 2. Provides consistent and constant lubrication of all types of ball, roller and plain bearings
- NEW 120ml capacity
- NEW compact design enabling application in hard to reach places
- NEW transparent housing making it easier to monitor lubricant levels
- Selectable 1,3,6 or 12 month dispensing periods
- Fully automatic
- Easy to install and maintenance free
- Grease temperature range -50°C to +160°C
- Unilube dispenser temperature range 0°C to +40°C
- NSF H1 Registered



120ml Dispenser - **Code: 7451T15910**

Rocol Sapphire 2 Bearing Grease

- Triple life bearing grease
- Extended lubrication intervals
- Excellent load carrying capacity



400g Tube - **Code: 7451T12171**

Rocol Sapphire Hi-Pressure 2

- Heavy duty, clay thickened grease containing molybdenum disulphide for enhanced bearing life in plain bearings
- Extreme load and wear performance
- Excellent corrosion protection
- High resistance to water wash out
- Extended lubrication intervals
- Temperature range -20°C to +150°C



500g Tin - **Code: 7451T12013**

Rocol Sapphire Extreme 2 Grease

- High performance long life bearing grease containing molybdenum disulphide (moly) for use in plain and roller bearings operating in arduous conditions
- Excellent resistance to vibration and shock loads
- Very stable at high temperatures
- Extreme load and wear performance
- Extended lubrication intervals
- Good corrosion resistance
- Temperature range -25°C to +250°C



400g Tube - **Code: 7451T12211**

Rocol Sapphire Premier Grease

- Excellent high temperature performance
- Good high speed performance
- Compatible with most plastics and rubbers



380g Tube - **Code: 7451T12471**

Rocol Sapphire Aqua-Silicone

- High temperature translucent silicone grease approved for use with potable water. Designed for the lubrication of slow speed bearings, slides and similar applications
- Water regulations Advisory Scheme - Approved product
- Excellent high temperature performance range
- Ideal for the assembly of rubber 'O' rings and seals
- Good resistance to chemicals, oils, water and gasses
- Compatible with most rubbers and plastics
- Temperature range -40°C to +200°C

85g Tube - **Code: 7451T12251**
 500g Tin - **Code: 7451T12253**



Rocol Sapphire 1 Unilube

- Fully automatic
- Contains Sapphire Grease
- 1,3,6,12 month lubrication intervals

120ml Dispenser - **Code: 7451T12710**



Rocol Sapphire Aqua 2

- A high performance grease designed to give superior resistance to water washout. For use in all types of ball, roller and plain bearings
- Outstanding long term water resistance, even when submerged
- Excellent corrosion protection
- Extended lubrication intervals
- Good load and wear performance
- Temperature range -20°C to +150°C

380g Tube - **Code: 7451T12751**



Rocol Sapphire Hi-Load 2

- A long life soap thickened bearing grease particularly suited for slow moving bearings subjected to heavy loads, shock and vibration
- Triple life bearing grease
- Extreme load and wear performance
- Extended lubrication intervals
- Revolutionary multi complex grease
- Good corrosion resistance
- Temperature range -30°C to +150°C

400g Tube - **Code: 7451T12761**



Rocol Sapphire Grease NLGI1

- Revolutionary long life bearing grease for optimum lubrication. Suitable for all types of ball, roller and plain bearings
- Triple life bearing grease
- Extreme load and wear performance
- Extended lubrication intervals
- Revolutionary multi complex grease
- Good corrosion resistance
- Temperature range -30°C to +150°C

400g Tube - **Code: 7451T12601**



Rocol Sapphire Instant Spray Grease

- Excellent high temperature performance
- Excellent corrosion protection
- Good high speed performance

400ml Can - **Code: 7460T34305**



Rocol Sapphire Precision Lube Spray

- Excellent penetrating lubricant
- PTFE fortified for increased lubrication
- Ideal for slides and chains

400ml Can - **Code: 7460T34341**



Rocol Moisture Guard Spray

- Five year indoor corrosion protective
- Flexible film - does not chip or crack
- De-watering film protects against corrosion caused by moisture or damp atmospheres
- Protects against condensation attack
- Does not attract dirt or dust
- Silicone free
- Does not normally require removal prior to use
- Available in clear and green formulations

400ml Can - Clear - **Code: 7468T69025**
 400ml Can - Green - **Code: 7468T69045**



Rocol Mould Release Spray

- Ultra thin non-silicone dry film PTFE release agent
- Dry film does not carry dirt and cause staining
- Particularly suited for high speed production
- Resists oxidation and action of water, steam and all common chemicals
- Can be used over painted or printed areas
- Highly economical - one pass coating
- Suitable up to 270°C

400ml Can - **Code: 7469T72021**



Rocol Penetrating Spray

- Excellent penetrating of rust, scale, grease, dirt etc
- Moly aids dismantling
- Light residual film for short term protection

300ml Can - **Code: 7452T14021**



Rocol Precision Silicone Spray

- Effective clean lubricant
- Ideal for slides, bearings and conveyors
- Resists oxidation and corrosion

400ml Can - **Code: 7460T34035**



Rocol Dry PTFE Spray

- Excellent light load lubrication
- Effective antistick properties
- Clean non toxic colourless film

400ml Can - **Code: 7460T34235**



Rocol PR Silicone Spray

- Wet film silicone release agent
- Ultra fine even film gives controlled application with complete coverage
- Gives an excellent gloss finish
- Highly economical - one pass coating
- Suitable up to 200°C



400ml Can - **Code: 7469T72015**

Rocol RTD Metal Cutting Liquid

- Metal cutting liquid which doubles tool life
- Medium viscosity fluid
- Suitable for severe cutting operations
- Applied directly to tap via automatic CNC applicator



400ml CNC Applicator - **Code: 7463T53072**
 5Litre Bottle - **Code: 7463T53076**
 20Litre Bottle - **Code: 7463T53078**

Rocol RTD Metal Cutting Compound

- Metal cutting liquid which doubles tool life
- Soft low melting-point paste
- Suitable for severe cutting operations
- Formulated to cling to the tool providing excellent cutting performance
- Rolls Royce approved - spec CSS 137
- Application by brush



50g Tin - **Code: 7463T53020**
 500g Tub - **Code: 7463T53023**
 5kg Tub - **Code: 7463T53026**
 18kg Drum - **Code: 7463T53028**

Rocol RTD Metal Cutting Spray

- Metal cutting lubricant which doubles tool life
- Medium viscosity liquid in an aerosol
- Suitable for severe cutting operations
- Ideal for use where accessibility is a problem
- Can be applied directly to moving tools



400ml Can - **Code: 7463T53011**

Rocol RTD Foamcut

- Foaming lubricant which doubles tool life
- Clean low odour foaming spray
- Suitable for severe cutting operations
- Ideal for use where accessibility is a problem
- Can be applied directly to moving tools



300ml Can - **Code: 7463T53041**

Rocol RTD Cleancut Liquid

- Suitable for aerospace & nuclear applications
- Low viscosity, water soluble lubricant
- Non-fuming, low odour characteristics
- Non-staining on yellow metals and aluminium
- Applied directly to tap/via automatic CNC applicator



350g CNC Applicator - **Code: 7463T53062**
 5Litre Drum - **Code: 7463T53066**

Rocol

TRI-Logic RTD Metal Cutting Lubricant

- Tapping fluid that fortifies cutting fluid
- Doubles tool life
- Reinforces water mix cutting fluid performance
- Low odour
- Water washable
- Applied directly to tap via automatic CNC applicator



350ml CNC Applicator - **Code: 7463T53003**
 5Litre Drum - **Code: 7463T53006**
 20Litre Drum - **Code: 7463T53008**

Rocol Multisol Cutting Fluid

- Inhibits corrosion
- Economical in use
- Low odour
- Pleasant and safe to use



Code: 7460T35216

Rocol Splatter Release Spray

- Silicone free
- Easy cleaning
- Rolls Royce approved - spec css 196



300ml Can - **Code: 7467T66080**

Rocol Wire Rope Spray

- Penetrates to lubricate the rope core
- Excellent de-watering properties
- Contains moly for increased lubrication



400ml Can - **Code: 7455T20015**

Rocol Z30 Spray

- Heavy duty waxy film in an aerosol form for long term outdoor corrosion protection of various machinery parts and pieces of equipment
- Good de-watering properties
- Good penetration
- Thin, flexible film - does not crack or chip
- Dry film - doesn't attract dirt or dust
- Does not contain silicones or Chlorinated solvents
- It is available in both fluid and aerosol form
- Ideal protection for components in storage and transit
- Approved to NATO standards
- Temperature range of -20°C to +110°C



300ml Can - **Code: 7461T37020**

Hylomar

Universal Blue Jointing Compound

- Polyester urethane based sealant
- Resistant to a wide range of fluids including, all industrial fuels, oils, water and brine

40g Tube - **Code: 7457T28060**



Reaming, Tapping & Drilling Lubricants



Key Selling Points

- Users of tapping fluids generally spend more than 100 times more on tooling than lubricant
- One tool can cost more than a bottle of tapping fluid
- Completed components can be worth £100's even £1000's
- Tool breakages, poor surface finish or geometry causes most scrap
- Machinists need to cut fast & accurately to be cost effective

RTD® lubricants are formulated to:

- Double tool life - reducing tooling costs
- Minimise tool wear & breakages - reducing tooling spend & scrap
- Promote excellent surface finish - improved quality, reduced scrap & reworked components
- Allow greater feeds & speeds - increased productivity & efficiency
- Multi metal compatibility - one product does all

With the **RTD®** technically advanced additive packages, the required amount of lubricant is greatly reduced, even on the toughest materials.

The **RTD®** range has been market leader for over 60 years. However severe the application, you can specify **RTD®** with confidence.

Typical users

- Fabrication workshop
- Production machine shops
- Toolrooms
- Maintenance departments
- Pipe fitter



RTD® lubricants available as liquids, compounds or sprays.

LUBRICANTS



WD40

- WD40 protects metal from rust and corrosion
- Penetrates stuck or jammed parts
- Displaces moisture and lubricates
- Cleans grease, grime and other marks

450ml WD-40 Aerosol - **Code: 8130T0450**
 250ml WD-40 Aerosol - **Code: 8130T0250**
 5ltr WD-40 Drum c/w Applicator - **Code: 8130T5000**
 100ml WD-40 Aerosol - **Code: 8130T0100**
 600ml WD-40 Aerosol - **Code: 8130T0600**
 25ltr WD-40 Drum - **Code: 8130T25L**
 WD-40 Spray Applicator - **Code: 8130TSA**



WD40 Smart Straw

- Dual action spray adds versatility
- Flip up for precision spray, flip down to spray larger areas
- Straw permanently attached

420ml Aerosol - **Code: 80130TSMART**
 420ml Slimstack - **Code: 8130TSMARTSLIM**

3-IN-ONE Oil

- It lubricates, cleans and prevents rust
- Its precise, easy to use drip spout enables precise lubrication, with no overspray or splatter

100ml Flexican - **Code: 8130T31STD**
 200ml Flexican - **Code: 8130T31LARGE**



3-IN-ONE Lithium Grease Spray (White)

- This water and heat resistant formulation provides you with a long-lasting, heavy-duty grease in an aerosol can
- Spray reduces friction while protecting against rust and corrosion
- It sprays on evenly as a liquid, and sets up dry for a thick coating
- It will not splatter, melt, run, wash off or freeze



400ml Can - **Code: 8130TLITHIUM**

3-IN-ONE Oil with PTFE

- Provides outstanding lubrication and corrosion protection under extreme high temperature, pressure and motion
- It may be used on axes, bushings, cables, snow blowers, lawnmowers and garage door tracks

250ml Can - **Code: 8130T31AEROSOL**



3-IN-ONE Silicone Lubricant Spray

- Provides high-performance lubrication and corrosion protection, in a quick-drying no-mess formula
- The silicone lubricant is safe for use on metal, rubber, vinyl, wood, and much more

400ml Can - **Code: 8130TSILICONE**



3-IN-ONE Anti-Seize Copper Grease

- Anti-Seize Copper Grease is a high temperature lubricant and anti-seize compound that protects metal components from corrosion, rust, water, heat and acid
- Capable of withstanding extreme temperatures, this grease is also enhanced with graphite for even better lubrication across the entire temperature range
- Once applied, a protective coating is formed which will not wash off or burn, therefore reducing metal-to-metal friction

Code: 8130T44167



WD40 3 In 1 Heavy Duty Cleaner

- Deep penetrating citrus foaming action quickly removes grease, oil, dirt and grime from engines, tools and equipment
- Works great on lawnmowers, chainsaws, power equipment, automotive, truck engines and parts as well as gears, chains, pulleys and industrial machinery

500ml Can - **Code: 8130T44615**



Tygris Bright Zinc Galvanising Spray

400ml - Code: TYGR224

Zinc content assists in corrosion prevention →

Resistant to salt spray and weathering →

High purity powders →

Excellent adhesion →



← Excellent heat resistance

← Aluminium powder gives a brighter finish to help blend with existing coatings

← Can be used on previously coated surfaces

← Quick drying

Tygris Clear Penetrating Oil

- Low viscosity for maximum penetration
- Easy to apply and works quickly
- Leaves a protective film against corrosion
- Also suitable for light lubrication duties
- De-watering capability

400ml - Code: TYGR212



Tygris Looz-n-It Penetrating Oil

- Fast penetration of rust and corrosion deposits
- Works effectively in wet and damp conditions
- Water repellent
- Displaces moisture
- Excellent lubrication properties
- Cleans and degreases
- Removes moisture from ignition systems

400ml - Code: TYGIS1



Tygris Heavy Duty Galvanising Spray

- High zinc content for maximum corrosion protection, including salt spray
- Zinc powder in the product is of high purity
- Can be used on previously coated surfaces
- Excellent lubrication properties
- Can be over-coated

400ml - Code: TYGR239



Tygris Clear Fine Oil

- Releases seized and rusted parts
- Effective on small and delicate components
- Rapid penetrating action
- Use on metallic components
- Low viscosity

400ml - Code: TYGR211



Tygris Water Displacing Anti-Rust Agent

- Silicone free
- Powerful water displacement properties
- Leaves a shield against further moisture ingress
- Leaves a protective film, guarding against corrosion
- Good general lubrication for most components
- A rapid penetrant for seized fixings

400ml - Code: TYGR213



Tygris Chain & Wire Lubricant

- Use on chain blocks, drive chains, fork lift chains and wire ropes
- Extreme pressure additives for heavy loads
- Excellent lubrication properties
- Resistant to flinging off
- Penetrates deeply
- Only a thin film is left on the surface for corrosion prevention
- High resistance to wash off

400ml - Code: TYGR220



Tygris Copper Anti-Seize

- Effective up to 1100°C
- Water and acid resistant
- Use on a wide range of metals
- Prevents seizure of threaded parts
- Will not burn or wash off
- Eliminates brake squeal
- Assists in assembly and disassembly of components

400ml - **Code: TYGR234**



Tygris Moly Dry Film Lubricant

- Dry Lubricant - does not attract dirt
- Durable coating
- Outstanding adhesion
- Extended service life
- Withstands high loads
- Working temperature to at least 350°C
- Water and chemical resistant
- Anti static properties

400ml - **Code: TYGR218**



Tygris White Grease with PTFE

- High water resistance for marine use
- Prevents corrosion in humid conditions
- Prevention of seizure
- Good mechanical stability
- Wide temperature range from -20°C to 110°C
- Reinforced with PTFE for improved slip properties

400ml - **Code: TYGR223**



Tygris Food Safe Lubricant

- Contains food contact safe products
- No animal derivatives
- Silicone free
- Odourless, colourless and non-staining
- Anti-throw properties for moving chains
- Penetrates cable cores
- Use on chains, slides, gears and linkages etc.
- Good temperature range

400ml - **Code: TYGR219**



Tygris Cutting and Tapping Fluid

- For cutting, tapping, reaming and turning
- Extreme pressure additives for difficult materials
- High pressure, frothy discharge to aid penetration
- Prolongs tool life and improves machined finish
- Reduces heat build up
- Suitable for use on all metals
- Incorporates corrosion inhibitors

400ml - **Code: TYGR214**



Tygris Non-Silicone Mould Release

- Non-silicone content to allow for overpainting, lacquering, overprinting, gluing or welding
- Excellent surface slip
- Effective where a high gloss finish is desirable
- Easily removed by conventional detergents

400ml - **Code: TYGR225**



Tygris Weld Spatter Release Spray

- Non-silicone - can be used with products that require finishing
- Rapid drying
- Prevents adhesion - spatter easily removed
- Colourless - non-staining
- Does not gum up when subject to heat
- Non-chlorinated for maximum safety

400ml - **Code: TYGR221**



Tygris specialist high-grade aerosol products help you maintain and protect equipment in any working environment. Every product is based on a proven formula - designed to do the job first time, every time.



LUBRICANTS/ACCESSORIES

Wesco Grease Gun

16oz - 10000PSI - Code: 7016T62
8oz - 3500PSI - Code: 7016T54

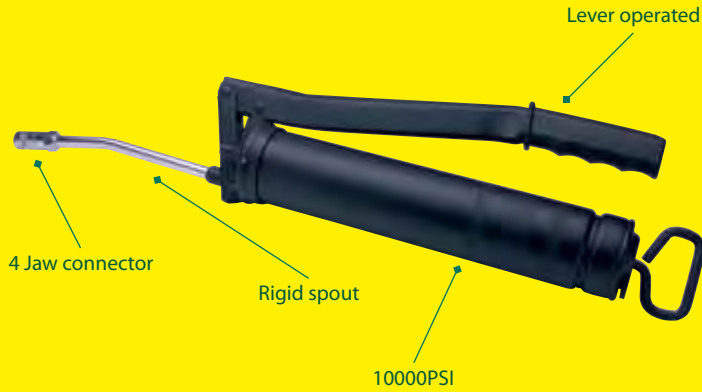

Wesco

Lithium Grease Cartridge

- For lever type high pressure grease guns
- Easy loading flip top bottom to eliminate mess and waste

400g - Code: 7017T400



Wesco Hook On Coupler

- For high pressure grease guns

Code: 7015T50113



Wesco 4-Jaw Light Duty Grease Coupler

- For light pressure grease guns

Code: 7014T50090



Wesco Grease Nipples

- DIN 71412
- Available in many sizes & threads



Wesco Grease Nipples - Straight

Code	Size
7022T70003	1/8" BSP
7022T70006	1/4" BSF
7022T70009	1/4" UNF
7022T70012	1/4" BSP
7022T70018	6mm x 1mm
7022T70021	8mm x 1mm
7022T70024	10mm x 1mm

Wesco Grease Nipples - 45°

Code	Size
7022T70004	1/8" BSP
7022T70010	1/4" UNF
7022T70013	1/4" BSP
7022T70019	6mm x 1mm
7022T70022	8mm x 1mm
7022T70025	10mm x 1mm

Wesco Grease Nipples - 90°

Code	Size
7022T70005	1/8" BSP
7022T70011	1/4" UNF
7022T70014	1/4" BSP
7022T70020	6mm x 1mm
7022T70023	8mm x 1mm
7022T70026	10mm x 1mm

LUBRICANTS/ACCESSORIES



Code	Size
7000T3340	3340-500Cc Fixed Spout Metal Oilcan
7001T40F	40F-500Cc Detach Spout Metal Oilcan
7000T3320	3320-350Cc Fixed Spout Metal Oilcan
7001T20F	20F-350Cc Detach Spout Metal Oilcan
7003T350	350Cc Moulded Body Pump Oilcan
7003T500	500Cc Moulded Body Pump Oilcan
7003T00105	1000Cc Moulded Body Pump Oilcan

Wesco Oilcans

- Strong deep drawn metal bodies with nylon pump unit
- 40F oilcan with flexible braided spout

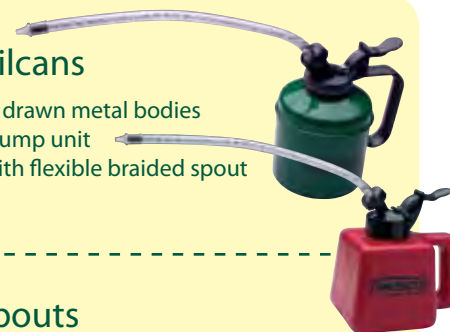

Wesco Spouts

- 9" Nylon Spout - **Code: 7001T40**
- 10" Flexible Braided Spout - **Code: 7001T40F**

Wesco Flexible Hose

- Working pressure 400bar
- Burst pressure 900bar
- For hand operated grease guns

12" - **Code: 7014T1200**
18" - **Code: 7014T1800**



Wesco Polythene Funnel - Flex Spout

- Detachable Flexi-spout and built in stainless steel filter

6" - **Code: 7007T0600**
9" - **Code: 7007T0900**



Wesco Polythene Funnel - c/w Filter

- Heavy duty funnel with filter

7" x 10" - **Code: 7007T40070**



Wesco Polythene Oil Pourer

- 2ltr & 5ltr c/w Flexi Spout

1ltr Polythene - **Code: 7010T1000**
2ltr Polythene - **Code: 7010T2000**
5ltr Polythene - **Code: 7010T5000**



Wesco Metal Round Rim Funnel

- Sturdily constructed from tin plate
- Finished in self colour

6" - **Code: 7006T0600**
8" - **Code: 7006T0800**
12" - **Code: 7006T1200**



Wesco 3-Jaw Grease Coupler

- Heavy duty

Code: 7014T35



Wesco Grease Coupler

- Slide on

Code: 7014T50114



Hardman Combination Pliers

Part of our plier range available on pages 112-116



Eclipse Button Magnets

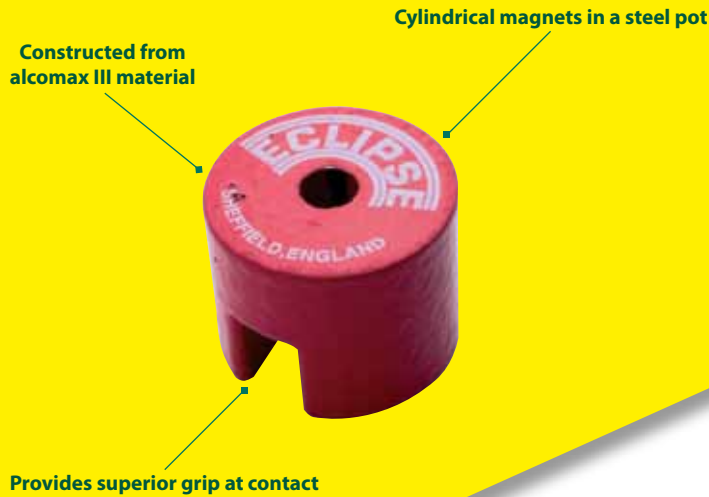

Code	Size
6463TE821	9.5mm x 12.5mm
6463TE822	12.7mm x 19.1mm
6463TE823	15.9mm x 25.4mm
6463TE824	25.4mm x 31.8mm
6463TE825	22.2mm x 19.1mm

Eclipse Bar Magnets

- Sold in pairs
- Educational, instrumentation, scientific applications
- Magnetic poles at each end
- Maximum operating temperature 550°C

Code	Size
6461TE806	25mm x 8mm
6461TE807	30mm x 10mm

Eclipse Shallow Pot Magnet

- Cylindrical magnets in a mild steel pot
- Ideal for securing items to thin sheet surfaces
- Constructed from alcomax III material

7.5mm x 19.1mm - Code: **6461T826L**
 8.7mm x 28.6mm - Code: **6465T827**
 10.35mm x 38.1mm - Code: **6465T828**



Eclipse Deep Pot Magnets

- Cylindrical magnets in a mild steel pot
- Provides superior grip at contact
- Constructed from alcomax III material

9.5mm - Code: **6464T829**
 12.7mm - Code: **6464T830**
 17.5mm - Code: **6464T831**
 20.5mm - Code: **6464T832**
 27mm - Code: **6464T833**
 35mm - Code: **6464T834**



Eclipse Power Magnets

- Traditional horseshoe design
- Attracting, clamping and securing steel parts
- Deep magnetic field attracts from a distance



Code	Size (L x H x W)
6462T811	30mm x 20mm x 20mm
6462TE812	40mm x 25mm x 25mm
6462TE813	45mm x 30mm x 30mm
6462TE814	58mm x 24mm x 40.5mm
6461T815L	70mm x 41.3mm x 57.2mm
6461T816L	79.4mm x 54mm x 82.6mm
6461T817L	60.3mm x 40mm x 62mm
6461T818L	79.4mm x 54mm x 85.7mm

MAGNETS



Eclipse Pocket Magnets

- Traditional horseshoe design
- Magnet designed with both poles in the same place
- Can be used in temperatures up to 550°C



Code	Size
6461TE802	22.2mm x 25.4mm x 7.9mm
6461TE803	27mm x 35mm x 15.9mm

Eclipse Magnetic Quick Clamp

- Provides rapid clamping of ferrous components
- Suitable for retrieval applications
- Contains powerful ferrite magnetic materials



Code	Pull
6469TE951	10 Kilo
6461TE953	15 Kilo

Eclipse Telescopic Pick Up

- Ideal for retrieving ferrous objects that are out of reach
- Suitable for car mechanics and electricians
- Extends to 660mm

147mm - 660mm - **Code: 6472TE967TP**



Eclipse Magnetic Bases

- For use in measurement inspection & positioning of workpieces
- Used with dial indicators to measure flatness/ concentricity of workpieces will clamp to curved or flat surfaces - dials not included
- Max pull 80kg

Push Button c/w Fine Adjustment - **Code: 6460TE901**
Lever Switch c/w H/D Fitment - **Code: 6460TE905**



FRONTLINE®

FRONTLINE® is a range of our best selling products that deliver significant benefits and cost savings. Benefits from using ROCOL® products include:

- Reduced downtime
- Maximises the life of tools & components
- Minimises scrap & waste
- Reductions in lubricant usage & spend
- Extended reapplication intervals
- Reduction in inventory



Irwin Marples Carpenters Try Square

6" - Code: 3639T0600
9" - Code: 3639T0900
12" - Code: 3639T1200



MARKING OUT

Stanley

Plastic Joiner's Bevel

- Sliding blade in hardened blued steel
- Chrome plated metal locking lever to secure blade
- High impact plastic moulded stock with accurately machined face combining lightweight and accuracy

190mm - Code: 2533T0718
228mm - Code: 2533T0900



Irwin Sliding Bevel

- Used for marking angle lengths; 250mm & 300 mm
- 225mm/9"

Code: 3639TM2226



Stanley Rosewood Joiner's Bevel

- High quality rosewood joiner's bevel
- Brass tips and blued steel blade for long lasting, high accurate marking

Code: 2873T0225



Irwin Maples Mortice & Marking Gauge

- Fitted with hard wearing hardened steel spurs
- Fitted with polyester friction pad between the thumb screw and stem to ensure a smooth sliding action

Code: 3640T2153
Code: 3640TM2154



Stanley Marking Gauge

- Plastic marking gauge
- Plastic stock with metal insert for abrasion resistance
- Stem calibrated for easy setting
- Graduation at 2mm

Code: 2527T247064



Blackedge Pencils

- Blue - Soft
- Red - Medium
- Green - Hard



Box 12 - Code: 6720T_____
Blue - 34320, Red - 34322, Green - 34324

Card 12 - Code: 6720T_____
Blue - 34328, Red - 34330, Green - 34332

Assorted Card - Code: 6720T34326

Hardman Carpenters Pencils

- Pack of 6
- Hard traditional pattern carpenters pencils

Code: AT04000



Markall Ball Paint Markers

- Marks with real paint, dries in 5 minutes
- Durable metal ball tip marks on wet oily smooth and rough surfaces; including metal, wood, plastic, glass and any hard surface
- Unbreakable plastic bottle with 1/8" steel ball tip
- Temperature range: -50°F to 150°F (-46°C to 66°C)

BMP White - Code: 8052BMPWHITE
BMP Yellow - Code: 8052BMPYELLOW

Stuarts Micrometer Blue

- Gives a clear perfect mark on any metal in any light
- Being a lubricant it cannot damage bearings or other working parts

Code: 8185TBUE



MARKING OUT



Stanley Black Fine Tip Permanent Marker

- Quick drying water resistant ink marks on almost any surface

Code: 2500T047316



Stanley Fatmax Black Fine Tip Permanent Marker

- Quick drying water and oil resistant marks on almost any surface
- Easy to grip non slip barrel and cap
- Easy to hook on a belt

Code: 2500T047314



Stanley Combination Square

- Cast iron professional combination square for accuracy & long life
- Blade etched with imperial / metric graduations
- Machined on all faces for accuracy
- Class II accuracy steel rule

Code: 2527T046151



Stanley Combination Square

- Precision die-cast body with 3 precision machined faces for accuracy
- Metric/Imperial graduations
- High visibility reading with etched and coated blade - rust resistant
- High quality brass nut and scriber fittings for long life
- 360° vial for all round visibility
- Class II accuracy steel rule

Code: 2513T246028



Hardman Combination Square

- Die cast zinc alloy stock
- English/metric graduated rule

Code: AT13100



Fisher 12" Combination Square

Code: 7177TPP1953ME

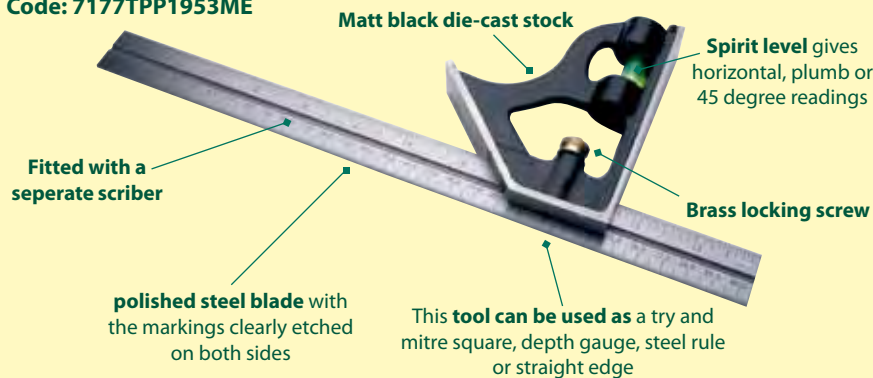

Fisher 12" Combination Set

- Carbon steel rule with etched imperial and metric graduations
- Metal stock
- Scriber
- Centre head
- Protractor
- Spirit level

Code: 7177TPP285ME

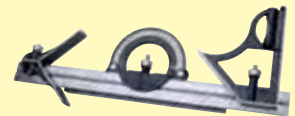

Stanley Roofing Square

- 600mm x 400mm
- Steel square with reversed reading scale

Code: 2530T0600



Fisher Roofing Square

- A high quality steel roofing square
- F12401MR - heavy duty
- With hanging hole for storage

16" x 24" - Steel
Code: 7177TF1011IMR
 16" x 24" - Aluminium
Code: 7177TF1140IMR
 16" x 24" - Heavy Duty
Code: 7177TF1240IMR

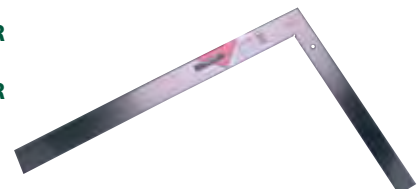



MARKING OUT

Marshalltown Dry Wall T Square

- Silver anodised finish
- Used for plasterboard measurement and cutting guide
- Imperial

Code: 7081TM27

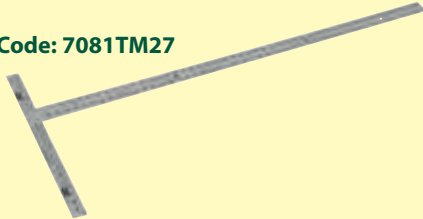

Stanley Adjustable Quicksquare

- Alloy construction for strength and long life
- Permanent markings for durability
- Can be used as a bevel, protractor or saw guide
- 3 main roofing scales marked for ease of use
- Ideal for marking or repetitive cuts

6" - Code: 2527T046050
10" - Code: 2527T046052



Stanley Folding Square

- Measuring 1200mm x 1200mm x 1720mm - 48" x 48" x 68"
- Solid light aluminium square ideal for checking and chalking in shell construction tiling and assembly of partitions
- Angles of 45° and 90°
- Easy to fold and store with hang hold

Code: 2527T145013



Hardman Folding Square

- Heavy duty folding aluminium square
- 90° & 45° markings
- Ideal for use when laying floors, patios & paving
- Complete with carry case

600mm - Code: AT13006
1200mm - Code: AT13007



Stanley Fatmax Xtreme Chalk Line

- On board hook storage for convenience
- Twisted polyester line with 50lb breaking strain for more abrasion resistance and longer life
- 5:1 gear ratio for quick rewind
- Durable die cast aluminium housing for strength and durability
- Can be used vertically as a plumb bob
- Integrated belt clip for convenience
- Patented chalk view window to see exactly how much chalk you have left
- Quick gear release button allows line extension without crank rotation

30m Xtreme Chalk Line - Code: 2500T547480



Stanley 30mtr ABS Chalk Line

- Die cast aluminium case for durability
- Stainless steel end hook for added durability and rust prevention
- Metal case for strength and long life
- 30g chalk capacity
- Can be used vertically as a plumb bob

30m Chalk Line Set - Code: 2500T047440
Metal Chalk Line Set - Code: 2523T30M



Stanley Chalk Refill

- Powder specially formulated for good adhesion and high visibility
- Blue - all round colour for interior and exterior use
- Red - for external masonry work, indelible
- White - for interior work such as carpet fitting

113g Blue Chalk - Code: 2526T45B
113g Red Chalk - Code: 2526T45R
113g White Chalk - Code: 2526T45W



MARKING OUT



Rocol Layout Ink Spray

- Forms an even, thin film
- Excellent contrast and definition
- Fast drying
- Scribes without flaking or chipping
- Easily removable
- Blue for bright surfaces, white for dark surfaces

400ml Can - White
Code: 7464T57025
 400ml Can - Blue
Code: 7464T57015



Rocol Layout Ink Fluid

- Forms an even, thin film
- Excellent contrast and definition
- Fast drying
- Scribes without flaking or chipping
- Easily removable
- Blue for bright surfaces, white for dark surfaces

1 Litre Bottle - White
Code: 7464T57044
 1 Litre Bottle - Blue
Code: 7464T57034



Cardoc Nylon Chalk Line

- For use with powdered chalk for marking between two points to give a straight line
- Braided line resists fraying and is useful for a plumb line as it does not spin round as a conventional twisted cord
- Size A - medium duty
- Size B - heavy duty

Size A 18m - Box of 24 - **Code: 6560TA18**
 Size B 18m - Box of 12 - **Code: 6560TB18**



Cardoc Laid Cotton Line

- Twisted cotton line for use with powdered chalk for marking between two points to give a straight line
- Size 218C - medium duty
- Size 318C - heavy duty

Size 218C 18m - Box of 12 - **Code: 6560T218C**
 Size 318C 18m - Box of 12 - **Code: 6560T318C**



Marshalltown

Braided Nylon Masons Line

- Not affected by extreme moisture
- For all layout applications

250" (Fluorescent) Pink - **Code: 7081TM631**
 250" (Fluorescent) Yellow - **Code: 7081TM632**



Cardoc Mason Line

- Made from orange polyethylene these lines are normally used for giving a straight edge for laying bricks etc
- Rotproof and waterproof

18m - Box of 12 - **Code: 6560T318**



Cardoc Cotton Line

- General purpose Cardoc cotton line

46m Ball - **Code: 6560T38**



Cardoc Nylon Line

- For use with powdered chalk for marking between two points to give a straight line
- Gold seal line resists fraying and is also for a plumb line as it does not spin round as conventional twisted cord
- Gold seal nylon has less stretch and is also the strongest

1/2kg - **Code: 6560TNO3**



Stanley Powerlock Tape

3m/10ft - Code: 2501T033523
 5m/16ft - Code: 2501T033553
 8m/26ft - Code: 2501T033526

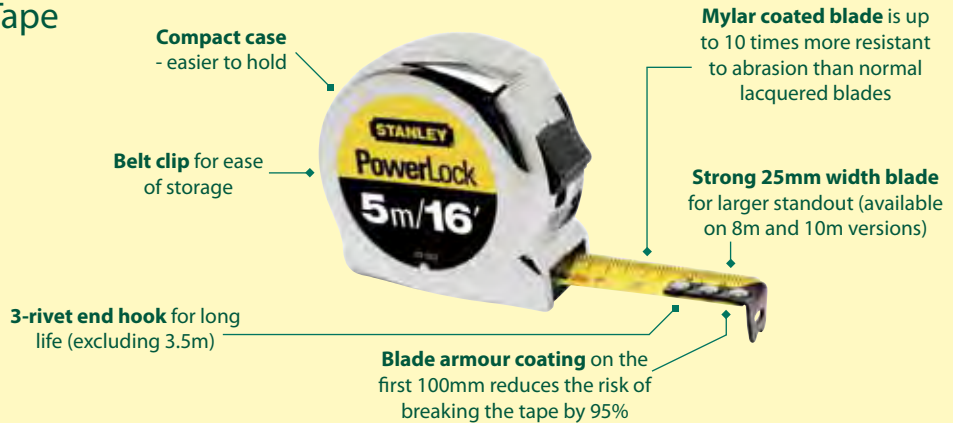

Stanley Fatmax Xtreme Tape

- Class II accuracy
 - Patented airlock slide lock
 - Mylar coated blade provides 10 times more resistance to abrasion than a lacquered blade
 - Blade armour on the first 6" of the blade reduces the risk of breaking the tape by 95%
 - High visibility blade with large easy to read graphics
 - 3-rivet end hook provides 40% stronger blade
 - 150% larger end hook securely holds to all building materials, including rounded or odd shaped items
 - 32mm wide blade providing 4m blade standout
 - Patented bi-material case for durability and comfort
- 5m/16ft - Code: 2500T533886
 8m/26ft - Code: 2500T533891
 10m/30ft - Code: 2500T533896



Stanley Fatmax Tape

- Class II accuracy
 - Huge standout 3.35m for easy one person measuring
 - Mylar coated blade provides 10 times more resistance to abrasion than a lacquered blade
 - Blade armour on the first 100mm of the blade reduces the risk of breaking the tape by 95%
 - Wide 32mm blade makes reading the numbers easy
 - 3-rivet end hook provides 40% stronger blade
 - Specially designed hook grabs on side, top or bottom for versatility
 - Cushion grip provides sturdy, slip-resistant hold
- 5m/16ft - Code: 2508T033719
 8m/26ft - Code: 2508T033726
 10m/30ft - Code: 2501T033805



Stanley Bi-Material Tape

- Compact & ergonomic bi-material case for comfort and ease of use
 - Belt clip for ease of storage
 - Tylon blade coating gives greater durability/wear resistance than lacquer
 - Matt finish blade reduces glare/reflection for easy reading
 - Tru zero end hook moves to compensate for accurate inside and outside measurements
- 3m/10ft - 12.7mm blade width - Code: 2512T030686
 5m/16ft - 19mm blade width - Code: 2512T030696
 5m/16ft - 25mm blade width - Code: 2512T030681
 8m/26ft - 25mm blade width - Code: 2512T030656



MEASURING

Hardman Tape Measure

- Dual reading English & metric
- Ergonomically shaped
- Rubber coated case to provide non-slip surface for better handling
- Class II accuracy

5m/16ft - **Code: AT15001**
8m/26ft - **Code: AT15002**
10m/30ft - **Code: AT15006**



Fisco Tuf-Lok Tape Measure

- High impact shock absorber.
- Multi-protected case, designed to withstand heavy on-site use
- Ergonomic case
- Positive action rocker lock
- Protected end-hook

5m/16ft
Code: 4300TTK5ME



Fisco Tri-Matic Tape Measure

- Tri-matic offers outstanding quality, durability and accuracy
- The compact, ergonomic case and well positioned lock offers superior handling and comfort in use

8m/26ft
Code: 4301T8000



Fisco Proflex Tape Measure

- Tough ABS case
- Automatic blade return with bump stop for added protection
- Polyester coated carbon steel blade

3m/10ft
Code: 4339TPFC3ME
5m/16ft
Code: 4339TPZC5ME
8m/26ft
Code: 4339TPWC8ME



Fisco Unimatic Tape Measure

- ABS case ultrasonically welded for added strength
- Positive action side lock brake
- Polyester coated carbon steel blade

3m/10ft
Code: 4305T3000
5m/16ft
Code: 4305T5000



Fisco Big T Tape Measure

- Tough rubber protection designed to survive heavy onsite use
- Rocker blade lock with a clear view rubber end grip
- Ergonomically shaped

5m/16ft
Code: 4300TBT5ME



Fisco Prolite Tape Measure

- Tough hi-viz ABS case
- Automatic blade return with bump stop for added blade and end hook protection
- Polyester coated carbon steel blade

3m/10ft - **Code: 4339T3000**
5m/16ft - **Code: 4340T5000**
8m/26ft - **Code: 4308T8000**



RST Surveyors Fibreglass Steel Tape

- 13mm blade width

30m/100ft - **Code: 7151T30M**
20m/66ft - **Code: 7151T20M**
50m/165ft - **Code: 7151T50M**



RST Metal Surveyors Tape

- Corrosion resistant steel case with black finish
- Metric and imperial steel blade with a folding stainless steel end claw
- 13mm blade width

30m/100ft - **Code: 7150T30M**
50m/165ft - **Code: 7150T50M**
100m/330ft - **Code: 7153T100M**

Fisco Meteor Long Tape

- Economical general purpose long tape for professional and home use
- Corrosion resistant steel case with grey finish
- Whitecote, polyester coated steel blade
- 10mm blade

10m/33ft - **Code: 4311T10M**
20m/66ft - **Code: 4311T20M**
30m/100ft - **Code: 4311T30M**



Fisco Ranger Long Tape

- Ruggedly constructed open frame tape with spade handle grip
- Twin mouth rollers for smooth rewind and low friction
- Corrosion resistant end piece

30m/100ft - **Code: 4341TRN3079**
50m/165ft - **Code: 4341T50M**



Stanley Fatmax Closed Steel Tape

- Class II accuracy
- 9.5mm Steel blade with large graphics for easy read
- Geared quick release button to pull blade from body without the handle rotating to protect the hand from cuts
- 5:1 gear ratio for quick blade return
- Bi-material case providing grip in damp conditions
- Barbed folding hook
- Carabiner hook to attach to belt loop
- Stainless Steel metal crank

30m/100ft - **Code: 2500T034132**



Stanley Powerwinder Long Tape

- Folding Tru zero end hook for accurate inside and outside measurements
- 13mm wide blade
- Rewinds 3 x faster with 3:1 gear ratio
- 2 sided blade graphics with fractional decimal/inch foot scales
- Reinforced blade end for long life
- End loop for easy pulling and anchoring
- Slip-resistant rubber grip handle
- Blade bumper to help prevent blade damage
- Comfortable and impact resistant construction for long life
- Class II accuracy

30m/100ft - **Code: 2500T234771**



Stanley Rustless Steel Rule 64R + 64FR

- Engineers precision steel rules
- Imperial side graduated to 16ths, 32nds, 64ths, 10ths, 20ths, 50ths, 100th
- Metric side graduated to 0.5mm
- Class 1 accuracy

150mm/6" - **Code: 2852T0600**
 150mm/6" - Flexible - **Code: 2852T0600FR**
 300mm/12" - **Code: 2852T1200**
 300mm/12" - Flexible - **Code: 2852T1200FR**
 600mm/24" - **Code: 2852T2400**
 1m/39" - **Code: 2852T3900**



Fisher Satin Chrome Rule

- Stainless steel with satin chrome finish
- Clear graduations
- Millimetre and 1/10" markings
- Hanging hole

150mm/6" - Flexible - **Code: 7171T0600**
 300mm/12" - **Code: 7171T1200**
 600mm/24" - **Code: 7171T2400**
 1000mm/39" - **Code: 7171T3900**
 2000mm/78" - **Code: 7171T7200**



Stanley Folding Steel Rule

- Subdivided in mm, figured every 10mm in mm; subdivided inches in 16ths on reverse side
- Stainless Steel rustproof construction
- Class II accuracy

600mm/24" - **Code: 2858T135331**



RST Folding Rule

- Precision hardened folding stainless steel rule
- Marked with acid etched permanent black figures and graduations in metric and imperial

600mm/24" - **Code: 7172T2400F**



Stanley

Line Of Cords Rule 60R

- Subdivided in mm and line of chords scale on one side; subdivided in mm and circumference scale in mm on the other side
- Class II accuracy

600mm/24" - **Code: 2859T0600**



MEASURING



Stanley Brass Counter Measure 1322GS

- Hard rolled brass with deep etched black figures and graduations for long life
- Metric/imperial version graduated in inches, 8ths top edge; figured in centimetres bottom edge. Metre and yard figures at end of measure
- Government standard
- Countersunk holes for fixing to counter top
- 1.2mm thick



1m/39" - Code: 2862T135441

Stanley Longlife Plastic Folding Rule 1302

- Virtually unbreakable tough engineering plastic
- Metric/imperial version graduated in inches, 8ths top edge

1m/39" - Code: 2847T1000



Moore & Wright Engineers Rules

- Made from fine quality steel which has been hardened and tempered to provide the ideal balance between flexibility and durability
- 'D' end with hanging hole
- Satin chrome anti-glare finish
- Permanent black high definition scale markings

150mm/6" - Code: 4003TER106F

150mm - Code: 4003TER306F

300mm/12" - Code: 4003TER112

150mm/6" - Code: 4003TER206F

300mm/12" - Code: 4003TER212

300mm - Code: 4003TER312

600mm/24" - Code: 4003TER424



Fisco Wooden Surveyors Rule

- The 6 fold surveyors rule remains rigid when extended
- Professional quality
- Hardwearing, moisture resistant finish
- Precisely inscribed and permanent graduations
- Cold rolled steel strip hinges treated with hypoid oil for longer life

2000mm - Code: 4328T2000



Leica Measuring Laser

- Disto D3a - Range 100m

- With a measuring accuracy of +/- 1.0mm the Leica DISTO D3a offers high precision at the touch of a button. The large illuminated display shows the measurement results and supplementary information clearly and legibly

Code: 9992TD3A



Leica Disto D210

The compact and handy entry-level model has many interesting functions and is still simple to use. Addition and subtraction, area and volume calculations for rapid and reliable site measurement. The last 10 results are stored

- Power Range Technology
- IP54 dust and water splash protection
- Illuminated 3-line display
- Automatic multifunctional end-piece
- Ergonomic and compact design with soft grip

Code: 9992TD210



Leica Disto X310

The new Leica DISTO™ X310 is the only laser distance meter to be dust-tight and protected against water jets - to IP65. In addition, it passes drop tests of up to 2m height. Thanks to the integrated tilt sensor, it can take indirect distance and height measurements absolutely precisely.

- 360° tilt sensor
- Smart Horizontal Mode™
- Height tracking
- Power Range Technology™
- Illuminated 4-line display
- Automatic multifunctional end-piece
- Robust housing

Code: 9992TX310



Leica Lino L360

The Leica Lino L360 projects laser lines quickly, accurately and further increasing the working range to 360°. The proven Power Range Technology™ ensures outstanding visibility of the lines. This combination makes the Lino L360 a valuable partner at any construction site and allows perfect levelling and alignment.

- 360° horizontal line close to the floor level
- 180° vertical line
- Well-dampened pendulum-based self-leveling
- 1.5mm @ 5m horizontal accuracy
- Rechargeable battery pack for extended operating time
- Dust-proof and jet protected - IP65



Code: 9992TL360

Bosch GLM 80 Laser Range Finder

- New functionality due to integrated 360° incline sensor
- Precise and easy to operate due to illuminated display which turns automatically
- Up to 25,000 individual measurements per battery charge due to Li-ion technology
- Automatic storage of the last 20 measured values and one constant
- Can be recharged via standard micro USB port
- Timer function can be switched on/off - for precise measurement from difficult positions
- Small and handy
- Reliable aid on any construction site due to robust design

Code: BTGLM80



Bosch GLM 80 + R 60 Laser Range Finder c/w Rail

- Measuring Rail R 60 Professional for use as a digital inclinometer
- Immediately ready for operation due to automatic detection of the measuring rail
- Illuminated display which turns automatically for optimum readability
- Maximum freedom due to Li-ion technology - up to 25,000 measurements per charge
- Automatic storage of the last 10 measured values and one constant
- New, combined measurement functions due to integrated 360° incline sensor
- Battery can be charged via a standard micro USB socket
- Small and handy

Code: BTGLM80R60



Bosch GLM 250 VF Professional Outdoor Range Finder

- Ideal for outdoor use: integrated telescopic viewfinder for optimum visibility of the laser point up to a distance of 250m
- Maximum measurement performance and precision, even in adverse lighting conditions, due to large glass lens and ceramic optics carrier
- Numerous easy-to-operate measurement functions for fast and accurate calculation of distances, areas and volumes
- Robust for use on the construction site due to dust and splash protection of IP54

Code: BTGLM250VF



Agatec A110G

- Rotating laser is ideal for installing drop ceilings, drywall and interior layout & renovations
- Self-leveling
- Can be used for levelling, vertical alignment, plumb and squaring
- Accuracy is +/- 1/8" at 100ft (+/- 3mm at 30m)

Code: AGA110G



Agatec DM100

- Handy and strong, this distancemeter measures the distance up to 30metres with a precision of +/-2mm
- Automatic calculation of volumes and surfaces
- Ergonomic design, rubber overmold
- Basic functionality

Code: AGADM100



Agatec RL110 Rotary Laser

- Cross line laser with floor-to-ceiling plumb beam
- Self-levelling
- Locked line angle mode to match an angle between two points
- Pendulum lock for safe transport
- Mounting bracket for wall layout
- Can use with optional detector outdoors

Code: AGARL110



Stanley Intellimeasure Distance Estimator

- Measures distances up to 12m/40"
- Accuracy is +/- 0.5%
- Calculates area: estimate materials for flooring, painting, wallpapering etc.
- Calculates volume: estimate heating/cooling requirements
- Displays last 3 measurements (no data retrieval necessary)
- Easy to read LCD screen
- Adds measurements
- Toggles between linear, area and volume modes
- Measures in metric and imperial units
- 2 x AAA batteries (not supplied)

Code: 2500T077018



Stanley TLM130i Laser Measurer

- Accuracy is +/- 1.5mm
- Calculator functions - addition, subtraction, area, volume and Pythagoras
- Measurements display metric and imperial measurements with up to 2 decimal places
- Plus/minus function quickly calculates multi measurements
- Pythagoras function
- 2 x AAA batteries (supplied)

Code: 2500T177911



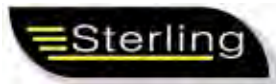

PADLOCKS

Sterling Brass Padlocks



Code: SLCPL151

Code	Size
SLBPL122	20mm
SLBPL123	25mm
SLBPL132	30mm
SLBPL142	40mm
SLBPL152	50mm
SLBPL162	60mm
SLBPL252	50mm *

* Long Shackle

Sterling

Brass Combination Padlocks

- Combination Padlock
- Solid brass body
- Corrosion resistant
- Steel Shackle
- Resetttable combination
- Easy to operate
- Clam packed

20mm - Code: SLCPL120
 30mm - Code: SLCPL130
 40mm - Code: SLCPL140
 50mm - Code: SLCPL151

Sterling Laminated Padlocks

- Laminated Steel Padlocks
- Steel laminated body
- Hardened steel chrome plated shackle
- Brass cylinder
- Mushroom pins
- Stainless steel pins
- Large number of key combinations
- Protective bumper
- 2 Nickel plated brass keys
- Pin tumbler locking mechanism
- Standard section keyway
- Available clam packed and Keyed Alike



Code	Size
SLLPL132	30mm
SLLPL142	40mm
SLLPL152	50mm
SLLPL162	64mm

Sterling Marine Padlocks

- Harsh environments
- Salt Spray tested
- Corrosion resistant
- Chrome plated solid brass body and cylinder
- Stainless steel shackle
- Mushroom pins
- Pin tumbler locking mechanism
- Stainless Steel Springs
- 2 Nickel plated brass keys
- Large number of key combinations
- Standard section keyway
- Available clam packed and Keyed Alike



Code	Size
SLMPL132	30mm
SLMPL142	40mm
SLMPL152	50mm

PADLOCKS



Sterling Weatherproof Padlocks

- Steel laminated body
- Protected hardened steel chrome plated shackle
- Double locking
- Thermoplastic weatherproof jacket
- Protective cover over keyhole
- Brass cylinder
- Standard section keyway
- Available clam packed and Keyed Alike

49mm - **Code: SLWPL149**
58mm - **Code: SLWPL158**



Sterling Heavy Duty Security Anchor

- Wall or floor mounting
- 10mm taper resistant anchor bolts
- Ball bearings for tamper resistant bolt heads
- 6mm hardened steel plate
- Ideal for use with Sterling security chains and cables
- Ideal for securing Motor Cycles and Scooters, ATV's and Bicycles, Construction Equipment, Lawn and Garden Equipment

Code: SLGA1



Sterling Disc Padlocks

- Laser welded stainless steel lock body/brass cylinder
- Hardened steel chrome plated closed shackle
- Anti-drill plate on cylinder (70mm and 90mm)
- Stainless Steel interior
- Deadbolt locking lever
- Mushroom pins
- Pin tumbler locking mechanism
- 2 Nickel plated brass keys
- Large number of key combinations
- Standard section keyway
- Available clam packed, boxed
- Keyed Alike - 60 & 70mm only



Code	Size
SLSPL080	60mm
SLSPL100	70mm
SLSPL120	90mm

Sterling High Security Armoured Steel Padlocks

- Closed shackle
- Solid brass body with hardened steel armour
- Hardened steel chrome plated shackle
- Rotating shackle
- Hardened steel ball bearing locking mechanism
- Anti-drill cylinder
- Pin tumbler locking mechanism
- Stainless steel springs
- 3 Nickel plated brass keys
- Large number of key combinations
- Standard section keyway
- Available clam packed, boxed and Keyed Alike
- (ASP290) double slotted ideal for chains



Code	Size
SLASP160	62mm
SLASP290	91mm

Sterling Security Hasp and Staple

- Corrosion resistant
- Hardened steel hinge pins, link and staple
- Concealed hinge pins and screws
- Additional link
- Complete with fixings
- Tough steel construction



Code	Size
SLDHS060	60mm
SLDHS080	80mm
SLDHS100	100mm

Sterling Security Hasp and Staple

- Corrosion resistant
- Hardened steel staple
- Concealed screws
- Complete with fixings



Code	Size
SLEHS075	75mm
SLEHS095	95mm
SLEHS115	115mm
SLEHS135	135mm
SLEHS155	155mm

Sterling Key Minder Storage Box

- Storage for door and padlock keys
- For home and office
- 10000 resettable combinations
- Discreet design
- Heavy body to resist attack
- Weather resistant
- 0-0-0-0 Auto stop opening in poor light



Code: SLKM1

Sterling Key Cabinet

- Available in 7 popular sizes
- Complete with colour key tags
- Indexing system for easy key selection
- Strong steel construction
- Rounded corners
- Secure lock with 2 keys



48 Key - **Code: SLK48**
110 Key - **Code: SLKC110**

Sterling Camlock

- 180° key - removable in locked and unlocked positions
- Individually bagged with hex nut, 36.5mm straight cam and steel clip
- Nickel plated
- Additional cams available from 25.5mm to 51.5mm
- Cranked cams available 34/6mm and 40/6mm
- 2 Nickel plated brass keys
- 10 year guarantee



Code	Size
SLC16	16mm
SLC27	27mm
SLC32	32mm

Sterling Security Chain

- Strong boron steel chain
- Case hardened steel
- Flexible polyester sleeve
- Sleeving riveted at each end
- Extra long link on chain end
- Hacksaw and bolt cropper resistant
- Weather resistant



Code	Size
SL809	8mm Case Hardened Square Link Chain 0.9 Metre
SL1020	10mm Case Hardened Square Link Chain 2.0 Metre

PLANES

Stanley Bench/Smoothing Plane

- Bench Plane Uses Blade 2575T012313
- Smoothing Plane Uses Blade 2575T012315
- Bench - 50mm Blade Width - **Code: 2556TNO04**
- Smoothing - 60mm Blade Width - **Code: 2556TNO41/2**

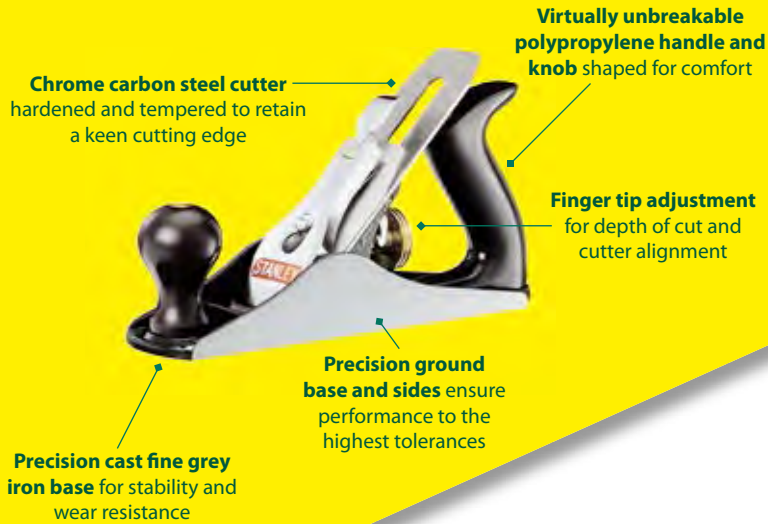

Stanley Jack Plane No5

- Professional fully adjustable metal plane
- General purpose for rapid stock removal prior to commencing assembly work
- 50mm Blade Width
- Uses Blade 012313

Code: 2557TNO05



Stanley Jointer Plane No7

- Professional fully adjustable metal plane
- For accurate truing of long edges for jointing wide boards edge to edge
- 60mm Blade Width
- Uses Blade 012315

Code: 2559TNO07



Irwin Record 04 Smoothing Plane

- Tungsten vanadium cutter blade
- Accurately machined blade setting
- Full adjustments
- Selected hardwood handle & knob
- Cast iron base, frog & lever cap
- Traditional brass adjustment nut

Code: 3532T04



Stanley Fore Plane No6

- Professional fully adjustable metal plane
- For stock removal and truing up long edges or levelling wide boards
- 60mm Blade Width
- Uses Blade 012315

Code: 2558TNO06



Stanley 102 Block Plane

- Manually adjustable
- General purpose ideal for model makers, craft and all light duty jobs
- 35mm Blade Width
- Uses Blade 012504

Code: 2565T0518



Stanley 601/2 Block Plane

- Fully adjustable fine grey iron
- Comes with pouch for convenient storage
- Low angle cutter
- For end grain and plastic laminates
- 35mm Blade Width
- Uses Blade 012504

Code: 2556T512060



Stanley 9 1/2" Premium Block Plane Standard Angle

- Base and frog cast as one to reduce chatter
- Precision machined base flat to .003" for accuracy
- Thicker blade 3mm to reduce chatter
- Ductile cast iron withstands drops from workbench
- Heavier body increased performance
- Solid brass adjustments for smooth operation
- Patented lateral adjustment locking feature for easy adjustment
- 40mm Blade Width
- Uses Blade 012508

Code: 2556T512020



Stanley 7" Adjustable Block Plane 220G

- Small professional fine grey iron
- Adjustable for depth of cut and alignment
- 40mm Blade Width
- Uses Blade 012331

Code: 2564T0700



Stanley No78 Rebate Plane Duplex

- Two cutter positions for regular and bull nose work
- Cutter adjustable for depth of cut in the rear position
- Supplied with an adjustable fence depth gauge and cutting spur
- 40mm Blade Width
- Uses Blade 112333

Code: 2567T1000



Stanley Bull Nose Rebate Plane No75

- Manually adjustable
- Accurately machined for precise work
- 28mm Blade Width

Code: 2569T75



Stanley Cabinet Makers Bull Nose Rebate Plane No90

- Fine adjustment for course or fine work
- Adjustable for depth of cut
- Removeable front for working into stopped rebates
- 25mm Blade Width

Code: 2568T0418



Stanley 63 Spokeshave

- Manual adjustment of cutter
- Round for concave shapes

Code: 2573T63



• All Stanley Spokeshave Use Blades 112350

Stanley 151 Spokeshave

- Fully adjustable for depth of cut and alignment by 2 milled screws
- For flat and convex surfaces

Code: 2573T151



- Fully adjustable for depth of cut and alignment by 2 milled screws
- Has round base for concave surfaces

Code: 2573T151R

Stanley Surform Metal Body Block Plane 153mm

- Strong heavy duty metal body for strength and durability
- Fitted with replaceable fine cut blade ideal for edges and confined work spaces
- Fits Blade 521398
- Thumb screw for quick blade release, no tools required

Code: 2500T521399



Stanley Plane Blades

2575T012313

- For use with Stanley Bench & Jack Planes



2576T012504

- For use with Stanley 140/102 Block & 601/2 Block Planes



2577T112333

- For use with Stanley No78 Rebate Plane Duplex



2575T012315

- For use with Stanley Fore, Jointer & Smoothing Planes



2576T012331

- For use with Stanley 180mm Adjustable Block Plane



2581T112350

- For use with Stanley Spokeshave Planes



Stanley

Surform Metal Body Block Plane 140mm

- Lightweight plastic moulded body for strength and durability
- Fitted with replaceable fine cut blade ideal for edges and confined work spaces
- Fits Blade 521398
- Thumb screw for quick blade release, no tools required

Code: 2627T021104



Stanley Surform Moulded Body Plane

- Lightweight plastic moulded body for strength and durability
- Fitted with replaceable standard cut blade ideal for general purpose use
- Thumb screw for quick blade release, no tools required
- 250mm

Code: 2627T021103

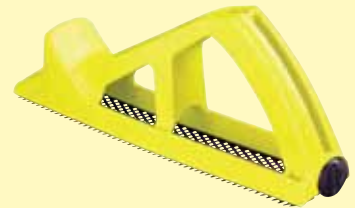

Stanley Surform Metal Body Planer File

- Polypropylene handle and die cast alloy body for strength and durability
- Can be set in two positions to be used as either a plane or a file
- Fitted with replaceable standard cut blade
- 310mm

Code: 2626T221122



Stanley

Surform Metal Body Flat File

- Strong heavy-duty metal body with rear removable robust handle in yellow polypropylene
- Knurled thumb grip for precision
- Accepts all types of 250mm blades for versatility
- For use with push or pull section depending on direction of blade installation
- 440mm

Code: 2626T221101



Stanley Surform Metal Body Plane

- Polypropylene handle and die cast alloy body for strength and durability
- Fitted with replaceable standard cut blade
- 315mm

Code: 2626T221107

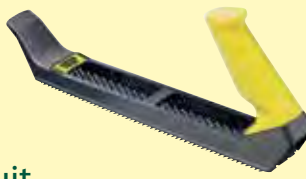

Stanley Surform Blades To Suit

• Fine Cut - 2628T021506

• Half Round - 2628T021507

• Metal & Plastic - 2628T021508

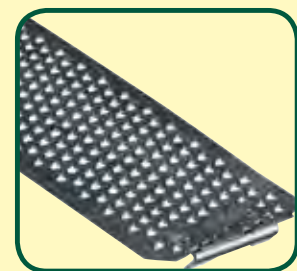
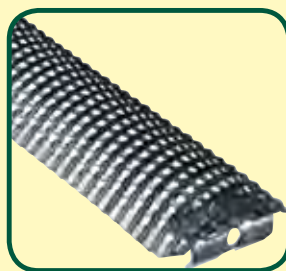
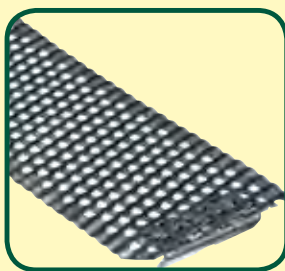

Stanley Surform Round File

- For enlarging holes and shaping tightly curved surfaces
- Tough Polypropylene handle for strength and durability
- Fitted with replaceable blade
- Thumb grip for comfort and ease of use
- Uses Blade 521291
- 400mm

Code: 2500T521297



Stanley Surform Shaver Tool

- Lightweight plastic moulded body for strength and durability
- Compact tool with curved blade for increased stock removal
- Works on pull stroke
- Simple click on blade replacement, no tools required
- Uses Blade 521515

Code: 2627T021115





PLASTERING, TROWELS & ACCESSORIES

Marshalltown Permashape Finishing Trowels - Durasoft Handle

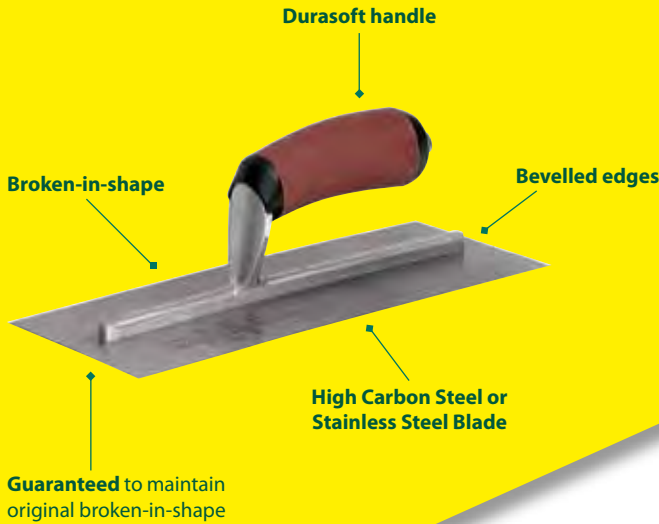

MPB Range

Code	Size
* 7090T300SD	13" x 5"
* 7090T400SD	14" x 4"
7090T1400D	14" x 5"
7090T1800D	18" x 5"
7090TMPB205D	20" x 5"

* Stainless Steel Blade

Permashape The Facts

- Broken in shape eliminates line & ripple marks right from the start
- Bevelled work edges prevent surface aggregate popping
- Guaranteed to maintain original broken-in-shape
- Aluminium alloy Xtralite mounting is lightweight but very strong
- Resilient Durasoft Handle provides a soft feel, reduces fatigue and offers excellent durability



Marshalltown Permashape Gold - Durasoft Handle

- Durasoft Handle
- Gold Stainless Steel Blade
- Broken in shape
- Bevelled edges
- Guaranteed to maintain original broken in shape

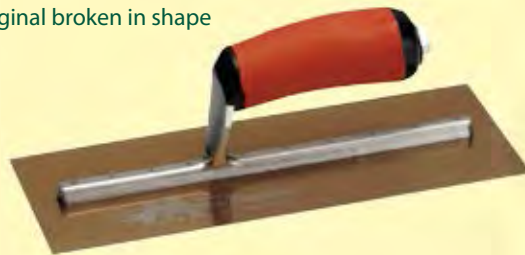

Code	Size
7090TMPB13GSD	13" x 5"
7090T1400GD	14" x 5"
7090TMPB165GSD	16" x 5"

Marshalltown Plasterers Trowel - Wood Handle

- Highest grade Carbon Spring Steel Blade
- Aluminium mounting is fully heat treated for strength
- Hardened steel rivets are used to attach the blade to the mounting



MXS Range

Code	Size
7090T1100	11" x 4 1/2"
* 7086T1100	11" x 4 1/2"
7090T1300	13" x 5"
* 7086T1300	13" x 5"
7085T1600	16" x 4"
7081TMXS205	20" x 5"

* Stainless Steel Blade

PLASTERING, TROWELS & ACCESSORIES



Marshalltown Plasterers Trowel - Durasoft Handle

- Highest grade Carbon Spring Steel Blade
- Aluminium mounting is fully heat treated for strength
- Hardened steel rivets are used to attach the blade to the mounting
- * Stainless Steel



MXS Range

Code	Size
7090T1100D	11" x 4 1/2"
* 7086T1100D	11" x 4 1/2"
7090T1300D	13" x 5"
* 7090T1300SD	13" x 5"
7085T1400FG	14" x 4 3/4"
* 7087T1400SD	14" x 4 3/4"
* 7085TMX77DSS	18" x 4 1/2"

Hardman Finishing Trowels

- Innovative comfort grip handle

11" x 4 1/2" - Code: **AT10001**
 14" x 4 3/4" - Code: **AT10002**
 11" x 4 1/2" - Stainless Steel
 - Code: **AT10005**



Hardman Flooring Trowel

- Innovative comfort grip handle
- 16" Flooring Trowel

Code: **AT10015**



Hardman Notched Trowel

- Innovative comfort grip handle

11" x 4 1/2" - Code: **AT10010**



Marshalltown Corner Trowels

- Lightweight tool made from one piece of flexible stainless steel
- Resilient durasoft handle with finger guard
- Blade set at 80° angle that flexes to form a perfect 90° to form a clean square corner on the outside

Code: **7096T25**



Marshalltown Corner Trowels

- Lightweight tool made from one piece of flexible stainless steel with aluminium mounting
- Resilient durasoft handle with finger guard
- Blade set at 103° angle that flexes to form a perfect 90° corner during use

4" x 5" - Code: **7096T23D**
 5" x 3 1/2" - Code: **7096T24**



Hardman Window Trowels

1/2" - Code: **AT10063**
 5/8" - Code: **AT10064**
 3/4" - Code: **AT10065**
 1" - Code: **AT10066**





PLASTERING, TROWELS & ACCESSORIES

Marshalltown Window Trowels

- Pronounced taper for sturdiness and flexibility in confined spaces
- Solid forged blade
- Durasoft handle

6 3/4" x 1/2" - **Code: 7101T018D**
 6 3/4" x 5/8" - **Code: 7101T020D**
 6 3/4" x 3/4" - **Code: 7101T022D**

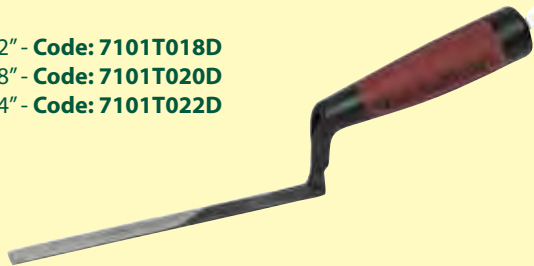

Marshalltown Hawks

- Durasoft handle
- Hard-rolled Aluminium

M1D - 13" x 13" - **Code: 7081T1300**
 M2 - 13 1/2" x 13 1/2" - **Code: 7081T1318**



Hardman Hawks

- Professional
- Strong
- Rubber hand protector

12" x 12" - Aluminium Hawk - **Code: AT10045**
 33cm x 33cm - Polyurethane Hawk - **Code: AT10043**



Marshalltown Taping Knife

- Made of the highest grade blue spring steel
- Each blade and backing plate fully temper welded to improve holding ability
- Comfortable contoured wooden handle
- Blade flexes just right for feathering

4" Joint Knife - **Code: 7081TM2504**
 6" Joint Knife - **Code: 7081TM2506**
 8" x 3" Taping Knife - **Code: 7081TM3508D**
 12" x 3" Taping Knife - **Code: 7081TM3512D**

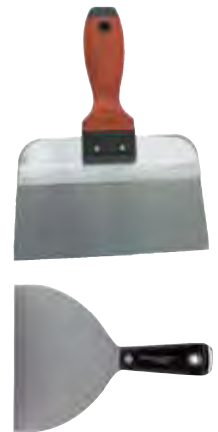

Marshalltown Dry Wall Scarifier

- Plastic Handle
- Blue Steel Blade
- 1/4" x 3" tines to scratch plaster undercoat

8" - **Code: 7081TM722**
 12" - **Code: 7081TM723**



Marshalltown Swivel Pole Sander

- Made of re-inforced die-cast aluminium bonded to a foam rubber pad
- Fast, positive clamps lock securely to hold the sandpaper in place
- Used for sanding drywall joints or plaster on walls and ceilings

9 3/8" x 3 1/2" - **Code: 7081TM26**
 Sander Pole - **Code: 7081TM28**



Marshalltown T-Square

- Silver anodised finish
- Clearly marked graduations

48" x 22" - **Code: 7081TM27**



Hardman Feather Edge

- Lightweight extruded aluminium
- One tapered edge for straightening and smoothing plasterwork
- One flat edge for tamping and smoothing concrete work

6ft/183cm - **Code: AT57039**
 8ft/244cm - **Code: AT57040**
 10ft/305cm - **Code: AT57041**



PLIERS



Knipex Combination Pliers

160mm - Code: **6135T0302160**

180mm - Code: **6135T0302180**

200mm - Code: **6135T0302200**

High leverage, eccentric joint for powerful gripping, seizing and cutting



Oil hardened and tempered

Cutting edges for soft, hard and piano wire



Hardman Combination Pliers

- Rust resistant, chrome vanadium steel
- Non-slip handles with slip guards
- Wide opening, wire cutting jaws

6"/160mm - Code: **AT86001**

7"/180mm - Code: **AT86002**

8"/200mm - Code: **AT86003**



Unior Combination Pliers

- Special composition for hardening and tempering
- Cutting edges induction hardened
- Head polished
- Chrome plate
- Heavy duty double component handles

160mm - Code: **6016T607870**

180mm - Code: **6016T607871**

200mm - Code: **6016T607872**

220mm - Code: **6016T608354**

Knipex VDE Combination Pliers

- Cutting edges separately induction hardened, suitable for cutting hard and soft wire
- Special tool steel, oil hardened
- Heavy insulated VDE tested handles

180mm - Code: **6135T0306180**

200mm - Code: **6135T0306200**



Unior VDE BI Combination Pliers

- Special composition for hardening and tempering
- Cutting edges induction hardened
- Head polished
- Chrome plated
- Heavy duty double component handles

180mm - Code: **6016T610422**

200mm - Code: **6016T610423**

220mm - Code: **6016T610424**



Knipex Diagonal Side Cutters

- For both soft and hard wire
- Induction hardened precision cutting edges
- Chrome vanadium electric steel, oil hardened material



Code	Size
6135T7002125	125mm - Comfort Grip
6135T7002140	140mm - Comfort Grip
6135T7002160	160mm - Comfort Grip
6135T7002180	180mm - Comfort Grip
6135T7402180	180mm - High Leverage
6135T7402200	220mm - High Leverage

Unior Diagonal Cutting Pliers

- Entirely hardened and tempered head polished, chrome plated with induction hardened cutting edges
- Heavy duty double component handles

140mm - Code: 6021T607883
160mm - Code: 6021T607884



Hardman Diagonal Cutting Pliers

- Angled head for close cutting on flat surface
- Rust resistant, chrome vanadium steel
- Non-slip handles with slip guards

5 1/2"/140mm - Code: AT86010
6"/160mm - Code: AT86011



Knipex VDE Diagonal Side Cutters

- VDE tested
- For both soft and hard wire
- Induction hardened precision cutting edges
- Material: vanadium electric steel, oil hardened

125mm - Code: 6135T7006125
140mm - Code: 6135T7006140
160mm - Code: 6135T7006160
180mm - Code: 6135T7006180



Unior VDE Diagonal Cutting Pliers

- Entirely hardened and tempered
- Head polished
- Chrome plated
- Induction hardened cutting edges
- Heavy duty double component handles

160mm - Code: 6021T610427



Knipex Long Nose Side Cutting Pliers

- Cushion grip
- Flat, round jaws with serrated gripping surfaces
- Cutting edges separately induction hardened
- Chain nose plier

140mm - Code: 6135T2502140
160mm - Code: 6135T2502160

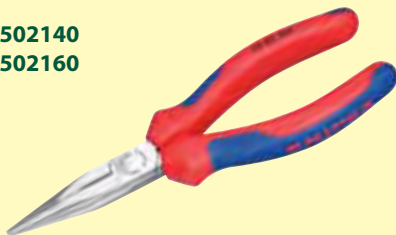

Unior Long Nose Pliers With Side Cutters

- Serrated gripping surface
- Half round jaws
- Cutting edges induction hardened
- Heavy duty double component handles
- Snipe nose plier

140mm - Code: 6032T607874
160mm - Code: 6032T607875
200mm - Code: 6016T607877



Knipex Long Nose Pliers

- Long, flat round jaws

Code: 6135T2612200



Hardman Long Nose Pliers

- Rust resistant chrome vanadium steel
- Non-slip handles
- Wide opening wire cutting jaws

6"/160mm - Code: AT86020
8"/200mm - Code: AT86021



Maun Diagonal Cutters

- Plated handles
- Made in England
- Toggle action spring open diagonal cutters
- Cuts wire up to 2mm in diameter and hardened wire up to 2mm

140mm - Code: 4572T0518
160mm - Code: 4572T0618

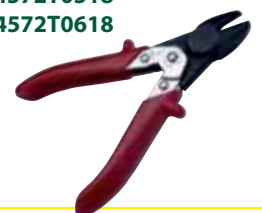

PLIERS



Knipex VDE Chain Nose Side Cutting Pliers

- Comfort grip
- Flat, round jaws with serrated gripping surfaces
- Bi-material handle

160mm - Code: **6135T2506160**



Unior VDE Long Nose Pliers With Side Cutters

- Serrated gripping surface
- Half round jaws
- Cutting edges induction hardened
- Heavy duty double component handles

140mm - Code: **6032T610434**
 160mm - Code: **6032T610435**
 200mm - Code: **6000T610437**



Knipex Waterpump Pliers (Cobra)

- The new generation of waterpump pliers, for easier safer work
- Press button action for faster and firm adjustment
- With box joint



Code	Size
6135T8701180	180mm
6135T8701250	250mm
6135T8701300	300mm
6135T8701400	400mm
6135T8701560	560mm

Knipex Waterpump Pliers (Alligator)

- With heavy duty box joint design
- Self gripping on pipes and nuts
- Pipe grip and spanner in one

180mm - Code: **6135T880180**
 250mm - Code: **6135T8801250**
 300mm - Code: **6135T8801300**



Hardman Groove Joint Pliers

- Offset jaws give maximum power when leverage is applied
- Made from high quality chrome vanadium steel, rust resistant
- Workshop grade
- Non-slip handles with slip guards

10"/250mm - Code: **AT86030**



Bahco Waterpump Pliers

- Phosphated and anti-corrosion treated
- Chrome vanadium
- Ergo grip handle for comfortable grip
- Speedy thumb setting allows adjustment of parallel jaws

250mm - Code: **6166T0250**
 315mm - Code: **6166T0315**



Crescent Waterpump Pliers

- Designed to grip all shapes like roads, pipes and cable connections
- Straight jaws and self locking jaw adjustment
- Forged hardened and tempered
- Non-slip cushion handles

178mm - Code: **4681T0700**
 254mm - Code: **4681T1000**
 305mm - Code: **4681T1200**

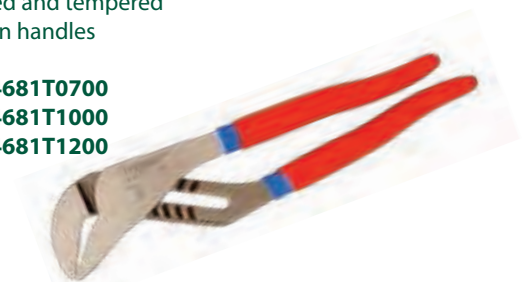

Knipex VDE Alligator Pliers

- Box joint design; high stability because of double guide
- Self locking on pipes and nuts, no slipping on workpiece
- Heavy insulated VDE tested handles

250mm - Code: 6135T8806250



Knipex End Cutting Nippers

- With cutting edges for soft and hard wire
- Also suitable for twisting and cutting binding wire

200mm - Code: 6135T6801200



Knipex Concrete Nipper

- For steel binding wire, quick, reliable and low cost
- To twist and cut binding wire in one operation

Code: 6135T9910300



Knipex Carpenters Pliers

- Cushion grip
- With striking force for driving nails
- Made from special tool steel, oil hardened

210mm - Code: 6135T510210

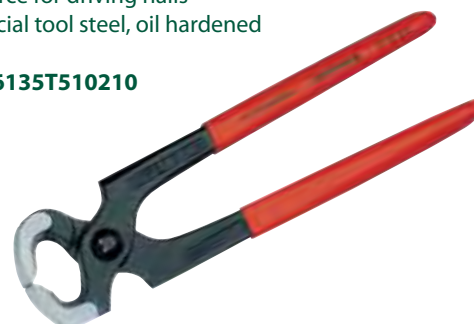

Crescent End Nippers

- Top quality end cutting tool
- Precision manufactured from forged alloy tool steel
- Handles with carefully designed leverage ratio to blades for easier cutting

7" Unsleeved - Code: 4682T0700

8" Unsleeved - Code: 4682T0800

7" Cushion Grip - Code: 4682T0700C

8" Cushion Grip - Code: 4682T0800C

9" Cushion Grip - Code: 4682T0900C

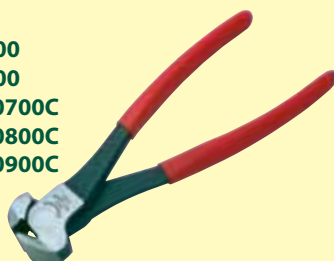

Hardman 6" Wire Stripper

- Spring for re-opening
- Non-slip handles with slip guards
- Adjustable screw to set required diameter
- Polished head

Code: AT86040



Hardman 3 Piece VDE Plier Set

- 8" VDE Combination Plier, 8" VDE Long Nose Plier, 6" VDE Diagonal Cutting Pliers
- Certified to DIN EN 60900
- For use to 1000v a.c and 1500v d.c
- Chrome vanadium steel
- Bi-material soft grip handles with slip guards

Code: AT86500



Maun Revolving Punch Plier

- Six heat treated punches, correct size can be selected by easily rotating the drum
- For punching holes in soft material such as leather etc.

Code: 4575T2230



Knipex Internal Circlip Pliers

- Cushion grip
- Solid style, forged
- Precision non-slip tips
- Material; chrome vanadium electric steel, oil hardened



Code	Size
6135T4411J1	140mm
6135T4411J2	180mm
6135T4411J3	225mm

Unior Internal Straight Circlip Pliers

- Material; special composition for hardening and tempering
- Entirely hardened and tempered
- Head ground
- Surface finish, phosphated
- Handles plastic dipped



Code	Size
6039T608751	140mm (8-13mm)
6039T608752	140mm (12-25mm)
6039T608753	180mm
6039T608754	220mm
6039T616741	300mm

Knipex External Circlip Pliers

- Cushion grip
- Solid style, forged
- Precision non-slip tips
- Material; chrome vanadium electric steel, oil hardened



Code	Size
6135T4611A1	140mm
6135T4611A2	180mm

Unior External Straight Circlip Pliers

- Material; special composition for hardening and tempering
- Entirely hardened and tempered
- Head ground
- Surface finish, phosphated
- Handles plastic dipped



Code	Size
6039T608735	140mm (3-10mm)
6039T608736	140mm (10-25mm)
6039T608737	180mm
6039T608738	220mm



Real Bosch

from the industry leader



PLUMBING

Monument Autocut Pipe Slice

- 15mm - Code: 6143T1715C
- 22mm - Code: 6143T1722Y
- 28mm - Code: 6143T1728Q
- Spare Wheels - Code: 6143T269N

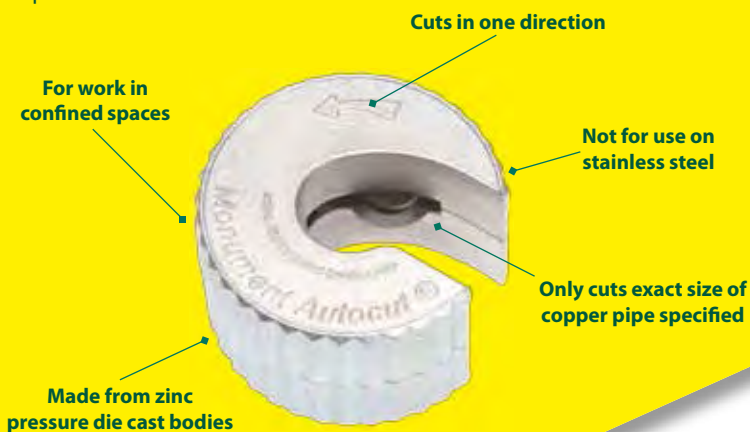

MONUMENT TOOLS

Bailey Universal Drain Rod

- Rods fitted with this type of joint to be rotated in a clockwise direction
- Manufactured from high grade polypropylene complete with solid brass joints

3/4" x 3ft - Code: 8165T1600



Bailey Universal Cleaning Rod Set c/w Bag

- 10 3/4" x 3 Bailey Blue Rods
- 4" Drop Scraper
- Plunger
- Double Worm Screw

Set In Blue Bag - Code: 8168T5431



Bailey Universal Plunger

- Builds up pressure of water which forces obstruction clear
- The plunger complete with rubber and leather washers enables the rubber plunger disc to be removed and replaced

4" - Code: 8167T1751
6" - Code: 8167T1752



Bailey Sweeps Brush 1853

- Drain and sweeps brushes with bristles in wooden stock
- Use for brick chimneys and coal burning appliances

16" - Code: 8171T1600



Bailey Clearing Wheel

- Guides rods around difficult bends and removes minor blockages by pushing material clear

Code: 8167T1740



Bailey Double Worm Screw

- Pierces blockages such as paper or rags and the obstruction is drawn back to clear the pipe

Code: 8167T1749



Bailey Drop Scraper

- Glides over small obstructions and drops into vertical scraping position to allow offending material to be dragged back towards the operator

Code: 8167T1741



Bailey Drain Test Plug

- Plastic cap
- For drain testing

4" - Code: 8183T1960
6" - Code: 8183T1961



Bailey Lockfast Drain Rod

1" x 6ft - Code: 8165T1657



Bailey Lockfast Plunger

4" Heavy Duty L/Fast Plunger

Code: 8168T3742

6" Heavy Duty L/Fast Plunger

Code: 8168T1898



Bailey Drain & Sweeps Brush - Wooden Stock

- Drain and sweeps brushes with bristles in wooden stock
- Use for brick chimneys and coal burning appliances

16" - Code: 8172T1600



Monument Deburring Tool

- Disposable tool, ideal for de-burring copper pipe
- Swivelling blade rotates freely allowing many de-burring operations

Code: 6143T3020C



Monument Pipe Slice

- For work in confined spaces
- Strongly made outer ABS plastic casing houses the inside mechanism made from steel which takes the load of the cut
- Cuts copper pipes once the gate of the tool is closed over the pipe

15mm - Code: 6143T15PC

22mm - Code: 6143T22PC

Spare Wheels - Code: 6143TW15PC



Irwin Record

Close Quarter Tube Cutter

- Industrial copper pipe slice
- Plastic body brand
- Ideal for those hard to reach places

15mm - Code: 3580T10507474

22mm - Code: 3580T10507476

28mm - Code: 3580T10507477



Monument Traditional Tube Cutter

- Made from zinc pressure die cast bodies
- All parts liable to wear are heat treated
- Fluted handles of sizes 1 and 2A are fitted with a spare wheel

Size 0 (3-22mm Capacity) - Code: 6143TNO0

Size 1 (4-28mm Capacity) - Code: 6143TNO1

Size 2A (13-43mm Capacity) - Code: 6143TNO2

Spare Wheels - Code: 6143T273A



Monument Semi-Automatic Pipe Cutter

- Enables 8-22mm diameter copper and thicker walled plastic pipes to be cut automatically
- After tightening, no further adjustment or feeding of the wheel into the tube is required
- Ideal for use in confined spaces

8-22mm - Code: 6143T300M

Spare Wheels - Code: 6143T301P



Monument Pipe Bending Machine

- Suits 15 & 22mm copper pipe

Code: 6143T2600K



Hardman Vinyl Pipe Cutter

- Cuts PVC, Aluminium or Plastic pipes
- When cutting PVC flexible pipe, revolve the pipe whilst compressing
- Cuts rigid plastic pipes to a maximum diameter of 42mm

Code: AT86050



Monument Plastic Pipe Cutter

- Very effective on PVC, MDP, polybutylene, polyethylene plastic, plastic overflow pipe, mini trunking, rubber hose and many more
- 25mm capacity

Code: 6143T2640E



Monument Plastic Pipe Cutter - Ratchet

- Very effective on PVC, MDP, polybutylene, polyethylene plastic, plastic overflow pipe, mini trunking, rubber hose and many more
- 42mm capacity

Code: 6143T2645T



Monument Plastic Pipe Cutter - Ratchet

- Very effective on PVC, MDP, polybutylene, polyethylene plastic, plastic overflow pipe, mini trunking, rubber hose and many more
- 60mm capacity

Code: 6143T2647Z



Irwin Record Handibender

- Ideal tool for the plumber, gas fitter and domestic heating engineer
- Hand held, it can be used in restricted spaces
- Compact and light enough to be carried from room to room but can also be held in a vice and used as a bench bender

Code: 3605T218M



Irwin Record Mini Bender

- Designed for bending small diameter copper, stainless steel, aluminium and steel tubes
- Particularly suitable for the hydraulic engineer, vehicle mechanic and tool maker

3-6mm - **Code: 3608T210**



Irwin Record Chain Pipe Vice

- Designed for use in confined spaces, where the pipe is on a trench, against a wall or close to a nest of other piping

182C - 4" - Code: 3581T400
183C - 8" - Code: 3581T800



Irwin Record Hinged Pipe Vice

92C - 2" - Code: 3582T200
93 1/2C - 3 1/2" - Code: 3582T318
96 - 6" - Code: 3582T600



Monument Internal Bending Springs

15mm - **Code: 6143T830V**
22mm - **Code: 6143T832B**



Monument Soldering & Brazing Pad

- Woven glass fibre
- Professional quality
- 12" x 12"

Code: 6143T2350X



Monument Soldering & Brazing Pad

- For protection of surrounding areas when soldering etc

Code: 6143T2348Q



Monument PTFE Tape

- For sealing screw threads in pipework
- Suitable for steam, water, gases and liquids
- 1/2" x 40ft

Code: 6143T5400



Everbuild PTFE Gas Tape

- For all common gases and liquids, also suitable for potable water
- Satisfies BG C IM/16, BS6974: 1989 and BS5292 Type C tests
- 13mm x 5mtr

Code: 3020T2PTFEGAS

Everbuild PTFE Water Tape

- WRAS & EN751-3 approved
- Complies with BS7786 1955 Grade L
- Also suitable for potable water
- 12mm

Code: 3020T2PTFEWATER



Everbuild

P19 Plumbers PTFE Silicone Spray

- PTFE Super Concentrate Silicone Spray is a multi-purpose, dry silicone lubricant, ideal for use in the plumbing industry
- It is ideal for use in easing the installation of all types of plastic pipe joints and threads, inserting rubber gaskets and O rings and 100's of uses
- Eases friction between and two surfaces, and stops squeaks

Code: 3016TP19SILSPRAY



Monument Radiator Spanner

- Zinc plated hexagon steel
- Slightly off set handle

Code: 6143T2053U



Monument Multi Purpose Key

- For gas, water and electric meter cupboards and some radiator valves
- 4 way

Code: 6143T2059M

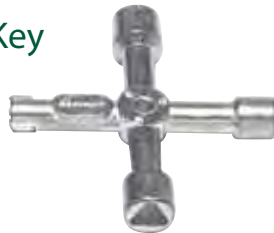

Knipex Multipurpose 10 Way Key

- Multifunctional key for the actuation of locking systems from the areas of facilities engineering, gas and water supply and shut-off-systems
- 8-arm version: two 4-way spider keys connected in a space-saving way using magnets
- Key and reversible bit joined by stable stainless steel wire
- Quality surface coating

Code: 6135T001101



Monument Adjustable Basin Wrench

- Used for loosening and tightening nuts in awkward positions
- Teeth will grip uneven shapes
- Swivel head allows access where fixed spanners will not operate
- 15-22mm capacity

Code: 6143T345V



Monument Basin Wrench

- The original 'Shetack' basin wrench for fitting back nuts and union nuts of pillar and bath taps behind basins, baths and sinks

Code: 6143T327R



Monument Back Nut Spanner Set

- 9,11,12,13 Tap Back Nut Box Spanner Set

Code: 6143T324H



Monument Manhole Cover Lifting Keys

- 'D' shaped end
- Tee handle for greater torque
- Zinc plated
- 1010L - for light duty manhole covers

125mm Pair - **Code: 6143T1010L**
500mm Pair - **Code: 6143TMLK20**
600mm Pair - **Code: 6143TMLK24**



Monument Crutch Stopcock Key

- For turning stopcocks on and off
- Turning handles has one chisel end for lifting covers

Code: 6143T339C



Monument Back Nut Spanner

- 27 x 32 Tap Back Nut Box Spanner

Code: 6143T323F



PLUMBING

MONUMENT TOOLS

MORSE Starrett

Monument Immersion Heater Spanner

- Made with octagon at the base of the cylindrical section to enable really tight immersion heaters to be loosened by striking the handle
- Overall clearance around the spanner is 7/8" (22mm) allowing easier fitting on insulated copper cylinders

3 3/8"/86mm Box Ring Immersion Heater Spanner - **Code: 6143T358J**
 3 3/8"/86mm Box Ring Immersion Heater Spanner - **Code: 6143T361T**
 3 3/8"/86mm Flat Steel Immersion Heater Spanner - **Code: 6143T360Q**



360Q



361T

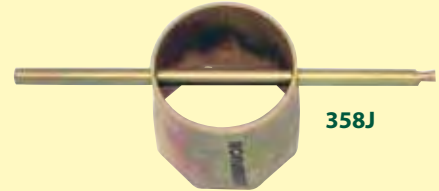

358J

Monument Tallow

- Used as a lubricant for threading and pulling cables through a conduit
- Best quality hard white tallow

Small - 0.25kg - **Code: 6143T261P**
 Medium - 0.5kg - **Code: 6143T262S**
 Large - 4kg - **Code: 6143T263V**



Monument Master Plunger

- For kitchen sinks, waste disposal units and showers
- More cubic centimetre displacement than traditional force cups
- Easily cleaned, removable handle

Code: 6143T1459W



Monument Force Cup

- Popular tools for clearing sink, basin and bath wastes

Medium - 4" - **Code: 6143T1457Q**
 Large - 4 3/4" - **Code: 6143T1458T**



Monument Toilet Plunger

- For toilets and gulleys
- More cubic centimetre displacement than traditional force cups
- Easily cleaned, removable handle

Code: 6143TMP1600



Monument Sink Waste Cleaner

- Galvanised steel wire with gripping handle for clearing sink, shower and bath wastes
- 12ft/3.6mtr

Code: 6143T910P



Monument Gas Test U Gauge

- For testing pipework for leaks using air before introducing gas
- For checking and setting correct gas pressures on domestic and commercial appliances
- Marked in millibars

30mb Plastic - **Code: 6143T257C**
 60mb Plastic - **Code: 6143T258F**



Monument Lead Dressers

- Specially designed for use on sheet lead, copper, zinc, aluminium etc
- Made with sufficient lift to clear users knuckles
- All wooden tools supplied with hanging tag for pegboard displays
- 2" Beechwood

Code: 6143T734D



Morse Plumbers Holesaw Kit

- This professional kit contains: 22, 29, 35, 38, 44, 48 and 50mm. M45P and M44 arbor

Code: 4504TAV04P02



Starrett Plumbers Holesaw Kit

- Kit contains: 19, 22, 29, 38, 44, 51 and 57mm

Code: 8470TK52000PE



Bailey Drain Testing Dye Blue

- These dyes are soluble in water and are used to locate the direction of water flow in pipes, drains etc. The best way to use the dye is to dissolve the required amount into about five litres of water and then add into the flow or tank. The dilution rates assume that the dye is being added to clean water; dirty water will require a greater concentration.

8oz - **Code: 8180T1992**



Rocol Leak Detector Spray

- Specially formulated aerosol for the rapid detection of positive pressure gas leaks. Tested to ensure plastic and copper pipe compatibility
- Suitable for use with most positive pressure gas systems
- For use on pipework carrying natural gas and LPG
- Safe for use with refrigerant gases
- Non Corrosive
- 360° valve for use in difficult to reach areas
- Meets the requirements of EN14291:2004

300ml Can - **Code: 7459T32030**



Rocol Flawfinder Cleaner Spray

- Fast drying, no residue cleaner
- Cuts through dirt, grease and grime
- Zero residue
- Prepares surface for non-destructive testing

300ml Can - **Code: 7465T63125**



Rocol Flawfinder Developer Spray

- Precision crack detection developer
- Highly absorbent white film for rapid results
- Highlights very fine cracks
- Sharp indication and geometry of defect to the naked eye
- Suitable for pressure testing and leak detection

400ml Can - **Code: 7465T63135**



Rocol Flawfinder Dye Penetrant Spray

- Precision crack detection penetrant
- Bright red even film
- Highly sensitive dye
- Water washable

300ml Can - **Code: 7465T63151**



Rocol Foliac Graphite Pipe Jointing Compound

- Flexible setting compound
- Efficient sealing to 1400 psi
- High & low pressure steam, water, air and gas
- Up to 450°C

300g Tin
Code: 7458T30021



Rocol Foliac Super Red Pipe Jointing Compound

- Hard setting pipe jointing compound for high pressures and sealing of threads and face connections
- Effective sealing for oils and petroleum products
- Resists vibration and thermal changes
- Suitable for petrol, diesel and mineral oils

375g Tin
Code: 7458T30051



Rocol Foliac Manganese Pipe Jointing Compound

- Dark grey hard setting but flexible compound for pipes flanges and face joints
- Hard setting compound
- Efficient sealing to 193 bar (2800psi)
- High & low pressure steam, water, air and gas
- Temperature range -20°C to +600°C

400g Tin
Code: 7458T30042



Rocol Gasseal Non Setting Sealant

- Compatible with low pressure LPG and natural oils
- Vibration resistant
- Independently tested to BSEN 7512:1997 Part 2 Class B

300g Tin
Code: 7457T28042



Rocol Twineflon

- A dynamic sealant which adjusts its state during installation
- Absolutely chemical resistant to the most aggressive chemicals, solvents, fuels and acids
- Creates a perfect seal by calandering the PTFE into a film in the exact thickness required between the two pipe ends
- Approved to all the latest regulations for thread sealing materials including use on potable water, natural gas and LPG systems
- Replaces all other sealants and tapes on all threads
- Easier and quicker to install than other sealants

175 metres - **Code: 7457T73295**



Sievert Jet DIY Blowtorch

- c/w 2203 175g screw on gas canister
- Will fit other EN417 cartridges
- For soft soldering, small brazing, paint stripping & other heating applications

Code: 7746T2293



Sievert Handyjet DIY Blowtorch

- c/w 2203 175g screw on gas canister
- Fits other EN417 cartridges
- For soft soldering, small brazing, paint stripping & other heating applications

Code: 7746T2294



Sievert Ultra Powerjet Gas Torch

- For plumbing/refrigeration/brazing/auto engineers and agricultural (Burns at 2400c)

Code: 7746T2335



Sievert Easy Jet Gas Torch

- Auto ignition & flame control
- For soft soldering, small brazing, paint stripping & other heating applications
- Fits all EN417 self-sealing cartridges

Code: 7746T2295



Sievert Pinpoint Burner

- With a 1" UNF thread - fits Rothenberger/Todays Tools & Bernzomatic throw-away cylinders
- Used for plumbing/refrigeration/brazing/auto engineers & agricultural
- Cylinder not included

Code: 7746T881647



Sievert Powerjet Torch Head

- Professional torch head only
- With a 1" UNF thread - fits Rothenberger/Todays Tools & Bernzomatic throw-away cylinders
- Cylinder not included

Code: 7746T2435



Sievert Mixed Gas Cartridges

- 175g Cartridge (EN417 fitting)

Code: 7746T2203



- 330g Cartridge (EN417 fitting)

Code: 7746T2204





PRECISION ENGINEERING

Moore & Wright Spring Joint Calipers - Outside

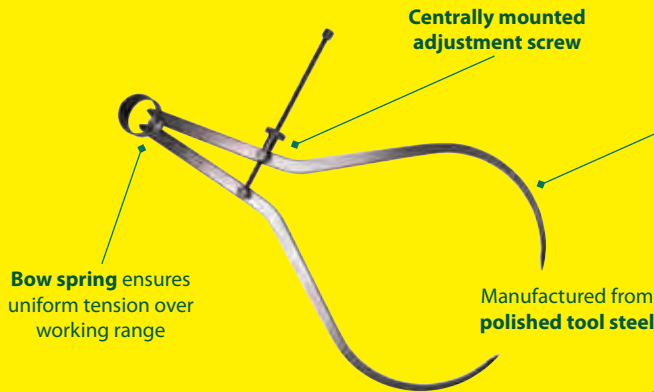

Code	Size
3940T523	75mm/3"
3940T4000C	100mm/4"
3940T6000C	150mm/6"
3940T8000	200mm/8"
3940T5210	250mm/10"
3940T5212	300mm/12"

Moore & Wright No331 Firm Joint Calipers - Outside

- Large headed nut & screw assembly provides a firm & rigid friction joint, with no play
- Manufactured from polished tool steel

150mm/6" - Code: **3942T0600**
 200mm/8" - Code: **3942T0800**
 300mm/12" - Code: **3942T1200**
 450mm/18" - Code: **3942T33118**
 600mm/24" - Code: **3942T 33124**



Moore & Wright No51 Spring Joint Calipers - Inside

- Bow spring ensures uniform tension over working range
- Centrally mounted adjustment screw
- Manufactured from polished tool steel

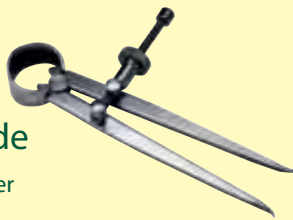

Code	Size
3940T300IC	75mm/3" Spring Joint Calipers
3940T100IC	100mm/4" Spring Joint Calipers
3940T600IC	150mm/6" Spring Joint Calipers
3940T800IC	200mm/8" Spring Joint Calipers
3940T1000IC	250mm/10" Spring Joint Calipers
3940T1200IC	300mm/12" Spring Joint Calipers

Moore & Wright No330 Firm Joint Calipers - Inside

- Large headed nut & screw assembly provides a firm & rigid friction joint, with no play
- Manufactured from polished tool steel

150mm/6" - Code: **3941T0600**
 200mm/8" - Code: **3941T0800**
 300mm/12" - Code: **3941T1200**



Moore & Wright Firm Joint Jenny Calipers

- Manufactured from polished tool steel
- Large headed nut & screw assembly provides a firm & rigid friction joint, with no play
- Bow spring ensures uniform tension over working range
- Centrally mounted adjustment screw

125mm/5" - Code: **3943T341**
 150mm/6" - Code: **3943T0600**



Moore & Wright No50 Spring Joint Dividers

- Manufactured from polished tool steel
- Points are hardened to over 550Hv
- Bow spring ensures uniform tension over working range
- Centrally mounted adjustment screw

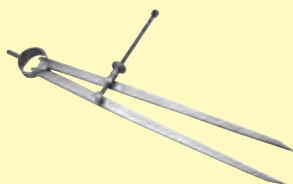

Code	Size
3940T300D	75mm/3" Spring Joint Dividers
3940T400D	100mm/4" Spring Joint Dividers
3940T600D	150mm/6" Spring Joint Dividers
3940T800D	200mm/8" Spring Joint Dividers
3940T1000D	250mm/10" Spring Joint Dividers
3940T1200D	300mm/12" Spring Joint Dividers



Moore & Wright Digital Caliper

- ABS/INC measurement
- Large LCD display
- On/off switch
- Zero point at any position
- Displays values in mm and inch
- Range: 0-150mm/0-6"

6" - Code: 4001T11015DBL
 8" - Code: 4001T11020DBL
 12" - Code: 4001T11030DBL

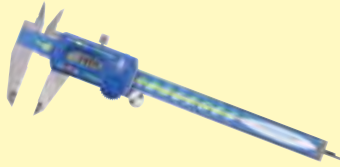

Moore & Wright Water Resistant Caliper

- Water and dust resistant to IP54 specification
- Functions: mm/inch conversion, on/off, zero setting
- Patented ceramic capacitive sensor
- Large LCD display
- CR2032 battery

6" - Code: 3940T11015WR
 8" - Code: 3940T11020WR
 12" - Code: 3940T11030WR



Moore & Wright Micrometers

- Capacity from 0-1"
- Blue textured frame finish
- Tapered bow frame
- Supplied complete with durable plastic pocket case



Code	Size
4001T965B	0.1" Capacity - Steel Anvils
4001T965M	0.25mm Capacity - Steel Anvils
4000T1961M	0.25mm/0.1" Capacity - Pearl Chrome Frame

Moore & Wright Digital Micrometer

- Large LCD display
- Tapered for easier access to difficult areas
- Hammertone finished frame with high quality insulated grip
- Tungsten carbide measuring faces and constant force ratchet on thimble
- Functions: mm/inch conversion, ABS/INC, zero setting
- Packed in plastic box with setting standard (over 25mm)

0-25mm/0-1" - Code: 4001T20001DBL
 25-50mm/1-2" - Code: 4001T1965DIG
 50-75mm/2-3" - Code: 4001T20003DBL
 75-100mm/3-4" - Code: 4001T20004DBL



The one and only original Stanley® retractable knife

For our range of Knives
 go to page 67



Please check for details.





PRECISION ENGINEERING

Moore & Wright Depth Gauge

- Full range rule adjustable
- Rules graduated on both sides
- Protractor plate is graduated 0-180°, scale resolution 12°
- 0-150mm depth gauge

Code: 3947T44M



Moore & Wright Safe & Sure Feeler Gauges

- Economical feeler set for general workshop use
- All blades hardened, tempered and polished
- Nominal thickness marked on each blade

4" Imperial - 10 Blades - **Code: 3992T911**

100mm Metric - 10 Blades - **Code: 3992T911M**



Moore & Wright Precision Feeler Gauges

- Manufactured to DIN 2275
- All blades hardened, tempered and polished
- Nominal thickness marked on each blade

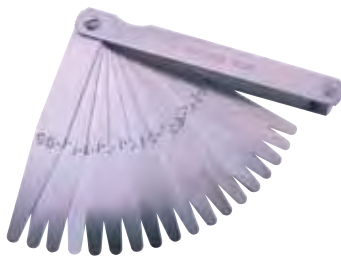

Code	Size
3990T387M	75mm - Metric - 13 Blades
3990T389M	100mm - Metric - 13 Blades
3990T390M	100mm - Metric - 20 Blades
3990T393M	75mm - Metric - 20 Blades
3990T395M	150mm - Metric - 20 Blades

Moore & Wright Screw Pitch Gauge

- Metric = 0.4-6.0 threads per mm
- Whitworth = 4-60 threads per mm

- 0.25-6.0 threads per mm



Code	Size
3946T800	Whitworth - 28 Blades - 55°
3945T801	S.I Metric - 30 Blades - 60°
3945T804	S.I Metric - 49 Blades - 60°

Code	Size
3946T806	Unified - 30 Blades
3946T806R	ISO Metric - 22 Blades - 60°

Moore & Wright Radius Gauge

- Designed to check both internal and external radius
- Accurately milled steel blades
- Marked with nominal size on each blade



Code	Size
3944T204MR	0.75-5mm - Metric - 18 Blades
3944T204MA	5.5-13mm - Metric - 16 Blades
3944T204R	1/32"-17/64" - Imperial - 16 Blades
3944T206A	9/32"-33/64" - Imperial
3944T206M	0.75-5mm - Metric



Moore & Wright Engineers Level

- Main vial sensitivity of 1 minute
- Each level is fitted with a main, cross and plumb vial
- Main vial protected by rotating shroud
- Vial solution maintains colour and fluidity under all workshop conditions
- Precision ground cast base with vee groove for location on cylindrical work
- Resolution - 0.3mm per metre 0.0035" per foot

ELS - 6 1/2" - Code: 4025TELS
ELM - 12" - Code: 4025T1200



Moore & Wright Mini Mag Level

- Embedded magnets on 3 sides
- Measuring range 360° (4 x 90°)
- Resolution 0.05°
- Accuracy +/- 0.2°
- Standard 9V battery
- Dimensions: L60mm x H60mm x W35mm

Code: 4025T57001S



Maun Engineers Straight Edges



Code	Size
4576T0500	500mm Aluminium Lightweight Extruded
4576T0600	600mm Aluminium Lightweight Extruded
4576T1250	1250mm Aluminium Lightweight Extruded
4576T2000	2000mm Aluminium Lightweight Extruded
4577T0500	500mm Steel Metric Straight Edge
4577T0800	800mm Steel Metric Straight Edge
4577T1000	1000mm Steel Metric Straight Edge
4577T1200	12" Steel Imperial Straight Edge
4577T1800	18" Steel Imperial Straight Edge
4577T2400	24" Steel Imperial Straight Edge
4577T3000	30" Steel Imperial Straight Edge
4577T3600	36" Steel Imperial Straight Edge
4577T4800	48" Steel Imperial Straight Edge
4577T5400	54" Steel Imperial Straight Edge
4577T6000	60" Steel Imperial Straight Edge
4577T7200	72" Steel Imperial Straight Edge

Moore & Wright No400 Engineers Squares

- Workshop grade "B"
- Precision ground blade & stock
- Hardened and tempered blade



Code	Size
4022T0075B	3" Moore & Wright Engineers Squares
4022T0100B	4" Moore & Wright Engineers Squares
4022T0150B	6" Moore & Wright Engineers Squares
4022T0225B	9" Moore & Wright Engineers Squares
4022T0300B	12" Moore & Wright Engineers Squares



STANLEY

PRECISION ENGINEERING

Moore & Wright Traditional Combination Set

- Fully hardened and tempered precision rules with deeply etched graduations on both sides for ease of reading and long life
- Fully hardened and ground datum faces to resist wear
- Centrally mounted protractor vial allows unrestricted viewing
- Protractor has full 360° scale plate, graduate 0-180°
- Satin chrome scale plate on protractor
- Unique clamp rule allows positive location
- Square head offers the following fixed angles 15°, 30°, 45°, 60°, 75° & 90°
- Centre head offers a fixed 90° angle, for finding the centre of round bar stock up to 120mm diameter
- Clipped corner on rule to maximise capability

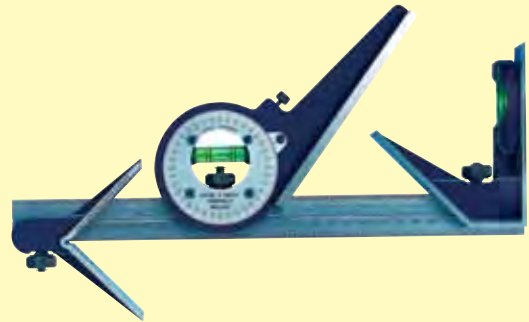

300mm - **Code: 4024TCSME12**

300mm/12" Spare Rule - **Code: 4024TCRME12**

600mm/24" Spare Rule - **Code: 4042TCRME24**

Moore & Wright Basic Combination Set

- Three measuring heads are attached to the stainless steel ruler, allowing versatile measurements on various types of work pieces
- Square head, protractor head and centre head
- For various measuring and marking applications
- Hardened and ground slide ways
- Stainless steel rule with engraved graduations

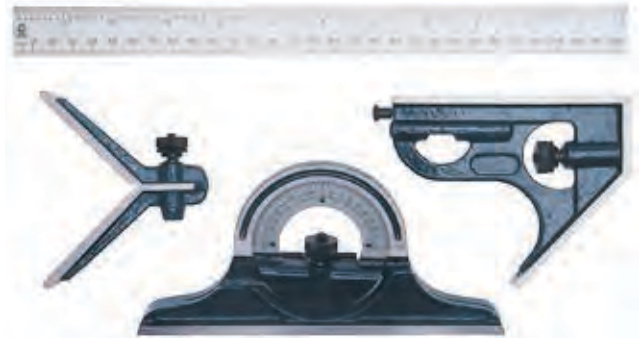

Code: 4024T52001

Moore & Wright Engineers Rules

- Made from fine quality steel which has been hardened and tempered to provide the ideal balance between flexibility and durability
- 'D' end with hanging hole
- Satin chrome anti-glare finish
- Permanent black high definition scale markings

150mm/6" - **Code: 4003TER106F**

150mm - **Code: 4003TER306F**

300mm/12" - **Code: 4003TER112**

150mm/6" - **Code: 4003TER206F**

300mm/12" - **Code: 4003TER212**

300mm - **Code: 4003TER312**

600mm/24" - **Code: 4003TER424**

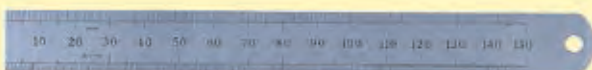

Stanley Rustless Steel Rule 64R + 64FR

- Engineers precision steel rules
- Imperial side graduated to 16ths, 32nds, 64ths, 10ths, 20ths, 50ths, 100th
- Metric side graduated to 0.5mm
- Class 1 accuracy

150mm/6" - **Code: 2852T0600**

150mm/6" - Flexible - **Code: 2852T0600FR**

300mm/12" - **Code: 2852T1200**

300mm/12" - Flexible - **Code: 2852T1200FR**

600mm/24" - **Code: 2852T2400**

1m/39" - **Code: 2852T3900**



Stanley Folding Steel Rule

- Subdivided in mm, figured every 10mm in mm; subdivided inches in 16ths on reverse side
- Stainless Steel rustproof construction
- Class II accuracy

600mm/24" - Code: 2858T135331

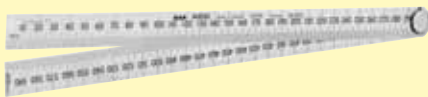

RST Folding Rule

- Precision hardened folding stainless steel rule
- Marked with acid etched permanent black figures and graduations in metric and imperial

600mm/24" - Code: 7172T2400F



Stanley

Line Of Cords Rule 60R

- Subdivided in mm and line of chords scale on one side; subdivided in mm and circumference scale in mm on the other side
- Class II accuracy

600mm/24" - Code: 2859T0600



Fisher Satin Chrome Rule

- Stainless steel with satin chrome finish
- Clear graduations
- Millimetre and 1/10" markings
- Hanging hole

150mm/6" - Flexible - Code: 7171T0600

300mm/12" - Code: 7171T1200

600mm/24" - Code: 7171T2400

1000mm/39" - Code: 7171T3900

2000mm/78" - Code: 7171T7200



Stanley Brass Counter Measure 1131GS

- Hard rolled brass with deep etched black figures and graduations for long life
- Metric/imperial version graduated in inches, 8ths top edge; figured in centimetres bottom edge. Metre and yard figures at end of measure
- Government standard
- Countersunk holes for fixing to counter top
- 1.2mm thick

1m/39" - Code: 2862T135441



Stanley Longlife Plastic Folding Rules 1302

- Virtually unbreakable tough engineering plastic
- Metric/imperial version graduated in inches, 8ths top edge

1m/39" - Code: 2847T1000



For our range of Auger Bits go to page 4



Eclipse Centre Punches 351 Series

- 3.2mm - Code: **3918T41**
- 4mm - Code: **3918T45**
- 4.8mm - Code: **3918T466**
- 6.35mm - Code: **3918T501**

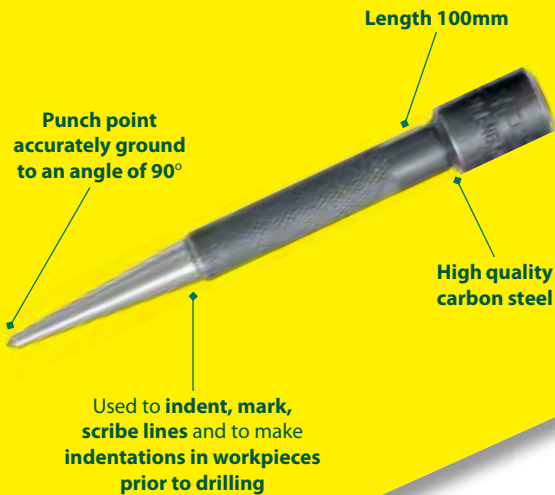

Priory

Round Head Centre Punches

- Quality tool steel
- Packed individually in a PVC wallet
- Chamfered at 60°



Code	Size
5300T124116	1/16"
5300T124332	3/32"
5300T12418	1/8"
5300T124532	5/32"
5300T124316	3/16"
5300T12414	1/4"
5300T12438	3/8"
5300T12412	1/2"

Eclipse Automatic Centre Punches

- Delivers a punch when hand pressure applied to knurled head
- One handed operation, hammer should not be used
- Depth of impression adjusted by turning knurled head

- 120mm - Code: **3921T65171R**
- 149mm - Code: **3912TE172**



Eclipse

Round Head Nail Punches 352 Series

- High quality carbon steel
- Designed to drive nail heads below the surface of wood
- Square head prevents rolling & gives larger striking face
- Cupped and bevelled points limit skidding off nail head
- 100mm length

- 1.6mm - Code: **3919T32**
- 2.4mm - Code: **3919T361**
- 3.2mm - Code: **3919T41**
- 4mm - Code: **3919T45**



Priory Nail Punches

- Square head
- Hardened & tempered cupped point
- Quality carbon tool steel



Code	Size
5300T66116	1/16"
5300T66118	1/18"
5300T66332	3/32"
5300T66SN4	4 Piece Nail Punch Set

PUNCHES



Eclipse Pin Punches

- Packed individually in a PVC wallet



Code	Size	Code	Size
3920T321	1/16" / 1.7mm	3920T464	3/16" / 4.7mm
3920T353	3/32" / 2.3mm	3920T474	7/32" / 5.3mm
3920T392	1/8" / 3.1mm	3920T492	1/4" / 6.1mm
3920T449	5/32" / 3.9mm	3920T537	5/16" / 7.6mm
		3920T555	3/7" / 9.5mm

Priory Pin Punches

- Packed individually in a PVC wallet
- Quality tool steel
- Heat treated
- Imperial



Code	Size	Code	Size
5300T135116	1/16"	5300T135316	3/16"
5300T135332	3/32"	5300T135732	7/32"
5300T13518	1/8"	5300T13514	1/4"
5300T135532	5/32"	5300T135516	5/16"
		5300T13538	3/8"

Eclipse Parallel Pin Punch Set

- 9 Piece Set

Code: 3920T161W



Priory Pin Punch Sets

- Imperial

9 Piece Set - Code: 5300T135S9

6 Piece Set - Long Series - Code: 5300T145S6



Priory Letter Punch Sets

- Suitable for punching wood or metal
- Best quality tool steel



Code	Character Size	Code	Character Size
5300T1812	2.0mm	5300T1815	5.0mm
5300T18125	2.5mm	5300T1816	6.0mm
5300T1813	3.0mm	5300T1818	8.0mm
5300T1814	4.0mm	5300T18110	10.0mm
		5300T18112	12.0mm

Priory Number Punch Sets

• Suitable for punching wood or metal



Code	Size
5300T18015	1.5mm
5300T1802	2.0mm
5300T18025	2.5mm
5300T1803	3.0mm
5300T1804	4.0mm

Code	Size
5300T1805	5.0mm
5300T1806	6.0mm
5300T1808	8.0mm
5300T18010	10.0mm
5300T18012	12.0mm

CHOOSE THE NO1 BUILDERS BRAND
EVERBUILD IN STOCK NOW,
 ASK FOR DETAILS.

RIVETERS



Eclipse Heavy Duty Riveter 2730

Code: 4027T2730

The market leading professional heavy duty riveter, best suited to engineering and maintenance projects

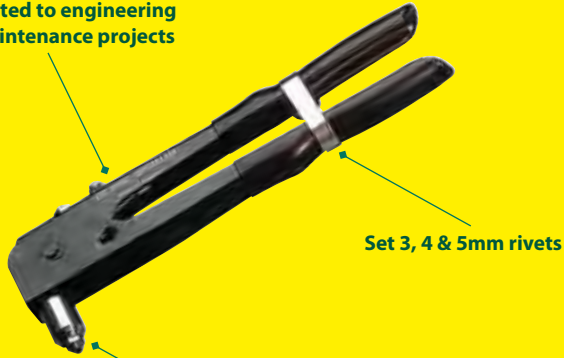

Set 3, 4 & 5mm rivets

Supplied with 3 interchangeable noses



Gesipa NTS Hand Riveter

- For easy operation
- Slim design of tool body for setting rivets in narrow places, self opening spring for automatic mandrel ejection
- Weight 1lb
- Total length 275mm

Code: 0719NTS-BOX



Hardman Heavy Duty Riveter

- Moulded non-slip handles for user comfort
- Handles are spring loaded for easy rivet loading and ejection
- Steel and die-cast construction for added strength and durability

Includes:

- 3 nose pieces - 3.2mm (1/8") - 4mm (5/32") & 5mm (3/16")
- Nose piece - wrench
- c/w size guide

Code: AT02100

Bahco 2681 Riveter

- Swivel head rivet tool
- Head swivels 360 degrees to rivet at any angle
- Will fasten metal, leather, canvas and vinyl using 2.4, 3.2, 4.0 or 4.8mm rivets
- With 3-interchangeable nose pieces which can be stored in the handle

Code: 6177T2681



Stanley

MR100 All Steel Riveter Contractor Grade

- Contract grade - heavy duty long lasting
- Accepts aluminium, steel and stainless steel rivets for wide range of applications
- 4 nose pieces & wrench store in handle

Code: 2500TMR100



Stanley

MR55 All Steel Riveter

- Easy to use spring loaded handle ejects rivet stem
- Rugged steel construction for long life
- 4 nose pieces & wrench store in handle

Code: 2500TMR55



Gesipa

SN2 Lazy Tong Riveter

- Weight 1.3lb
- Total length 260mm

Code: 0719SN2



Eclipse

Lazy Tong Riveter 2750

- One handed operation giving no loss in efficiency
- Useful on vehicle maintenance, agricultural projects and construction
- Sets 3, 4, 5 & 7mm rivets

Code: 4027T2750



Eclipse

Heavy Duty Lazy Tong Riveter 2750HD

- Ergonomic rubber grip handle
- Fixed handle makes the tool ideal for repetitive action and single handed operation
- Zinc plated steel for a smooth operating action
- Heavy duty hardened and tempered jaws

Code: 4027T2750HD



Hardman Lazy Tong Riveter

- Operating levers made from finest quality steel
- Hardened nosepieces for increased durability
- Hardened and self-lubricating jaws
- Strong and light aluminium body die-cast for reduced fatigue

Code: AT02201



Eclipse Long Arm Riveter 2760

- Long arms reduce to the minimum the effort required to set rivets for up to 6mm
- Probably the most powerful industrial hand riveter available today
- Set 4, 5 & 6mm rivets and 6mm monobolts

Code: 4027T2760



Gesipa Accubird Riveter

- Rechargeable 14 volt lithium battery
- 8.500N traction power
- Quick charger in steel case
- Stroke size 20mm
- Blind Rivets up to 5mm in all materials

Code: 0719A7250037L



Gesipa Powerbird Riveter

- Rechargeable 12 volt high power battery
- 13.000N traction power
- Quick charger in steel case
- Stroke size 20mm
- Blind Rivets up to 4.8mm steel and up to 6.4mm all materials

Code: 0719P7240031L



Eclipse

Threaded Insert Setting Tool 2745

- Designed to enable threaded nut inserts to be set by hand
- Supplied in a wallet complete with 4, 5, 6 & 8mm nose bushes and mandrels
- Supplied with additional 4, 5, 6 & 8mm threaded inserts

Code: 4030T2745



Gesipa GBM5 Rivet Nut Tool

Code: 0719GBM5



Gesipa GBM10 Rivet Nut Tool

Code: 0719GBM10



Eclipse Spiralux Thread Insert

- A selection of steel inserts

Code	Size
4031T45	4mm
4031T47	5mm
4031T49	6mm
4031T54	8mm



SAFETY WEAR



Vitrex Deluxe Safety Spectacles

Code: 4602T301260



Vitrex Safety Spectacles

- Clear polycarbonate specs with ventilated side arms
- Impact and abrasion resistant
- EN166

Code: 4602T301255



Vitrex Safety Shield

- Impact resistant, clear polycarbonate visor
- Adjustable face shield can be locked in position, with convenient 'nod-down' facility
- Lightweight & comfortable to wear

Code: 4602T301549



Vitrex Safety Goggles

- Impact resistant, clear polycarbonate
- Elasticated strap
- Suitable for woodwork, home renovation, painting and use with most domestic power tools

Code: 4602T302120



Vitrex Deluxe Safety Goggles

- Impact resistant, clear polycarbonate
- Large frame with wide angle, impact and abrasion resistant
- Elasticated strap

Code: 4602T301597



Plano Sun Protective Safety Glasses

- Latest Sporting Design
- All day comfort
- PC, UV, SP

Code: 4666TPLG14



Plano High Visibility Safety Glasses

- Sporting Design
- All day comfort
- PC, UV, SP
- Enhances sight in low light conditions

Code: 4666TPLG15



Plano Sun Protective Safety Glasses

- Flexible earpieces
- All day comfort
- PC, UV, SP
- Smoked lenses

Code: 4666TPLG18



Plano Clear Anti-Fog Safety Glasses

- Anti-fog design with built in ventilated side arms
- Non slip nose pads
- Supplied with neck cord
- PC, AS, UV, AF

Code: 4666TPLG33



Vitrex Cup Mask (pack of 3)

- Comfort mask, provides relief from coarse non toxic particles
- Suitable for nuisance dusts and pollens
- Can be worn with glasses or goggles
- Lightweight & comfortable to wear

Code: 4602T302880



Vitrex Premium Moulded Power Tool & MDF Respirator

- Breathe easy valve offers extra comfort when exerting greater physical effort/body movement
- Ideal for working in confined positions
- Protects lungs against fine toxic particles
- EN149:2001 FFP2

Code: 4602T302900



Vitrex Premium Moulded Sanding & Loft Insulation Respirator

- Protects lungs against fine toxic particles

Code: 4602T302897



Vitrex Sanding & Loft Insulation Respirator

- Protects lungs against fine non-toxic particles
- Standard EN149:2001 FFP1

Code: 4602T302896



Vitrex Charcoal Fold Flat Respirator

- Pocket sized fold flat design for easy and hygienic storage
- Colour coded noseclip for simple identification
- EN149:2001 FFP1

Code: 4602T301370



Vitrex Power Tool & MDF Respirator

- Suitable for working in normal conditions
- Protects lungs against fine toxic particles
- Pocket-sized fold flat design for easy and hygienic storage
- Colour coded nose clip for simple identification
- EN149:2001 FFP2

Code: 4602T301375



Vitrex Premium Multipurpose Respirator

- Pocket-sized fold flat design for easy and hygienic storage
- Colour coded nose clip for simple identification
- EN149:2001 FFP3

Code: 4602T301380



Vitrex Twin Filter Respirator EN140, EN143 P2S

- High performance respirator with replacement P2S twin filter pads
- Flexible silicone face-piece and elasticated harness, for a secure and comfortable fit
- Protects lungs against fine toxic particles
- EN140, EN143 P2S

Code: 4602T302644



Vitrex Replacement Filter Pads

- Replacement filter pads, 4 pack to fit 302644 respirator
- Protects lungs against fine toxic particles
- Suitable for use with most power tools
- Ideal for use with softwood, hardwood, MDF, metal and concrete

Code: 4602T302646



Vitrex Tapered Ear Plugs EN352 Part 2-5 Pairs

- Disposable foam ear plugs, shaped for easy insertion
- Smooth outer surface for better hygiene
- Suitable for most DIY and Powertool applications

Code: 4602T303085



Vitrex Ear Protectors EN352 Part 1

- Lightweight design with foam padded cups for extended use
- Fully adjustable contoured headband
- Suitable for DIY and Powertool applications

Code: 4602T301661



Vitrex Ear Caps

- Multipositional, can be worn over the head, under the chin or behind the neck
- Folds for convenient pocket storage
- Supplied complete with 2 pairs of replacement caps

Code: 4602T303065



Hardman Safety Helmet

- To EN397/EN398 specification

- Orange - (EN398) - **Code: AT58044**
- White - (EN397) - **Code: AT58045**
- Blue - (EN397) - **Code: AT58046**
- Yellow - (EN397) - **Code: AT58047**
- Red - (EN397) - **Code: AT58048**
- Green - (EN398) - **Code: AT58049**
- Yellow - (EN398) - **Code: AT58050**



Vitrex Safety Hat/Helmet

- High density polyethylene safety helmet with sweatband for extra comfort
- Ideal for DIY projects
- Adjustable internal harness to fit most head sizes
- Lightweight and comfortable to wear
- CE approved

Yellow - **Code: 4602T302150**

White - **Code: 4602T302149**



Yellow Criss Cross Latex Gloves

- Seamless knitted glove with an elasticated wrist and criss cross non-slip grip
- Ideal for handling awkward objects and materials such as glass and metal

Code: AT58904



Puggy Pu Coated Glove

Code: AT58907



Economy Grippa Gloves

- Latex coated palm for non-slip grip
- Ideal for various building projects and for handling rough materials such as bricks and slabs

Code: AT58900



Leg Latex Powdered Disposable Glove

- Box of 100

Code: AT58908



Canadian Rigger Gloves

- A rigger style leather palm providing protection for heavier work

Code: AT58902



Heavy Duty Rigger Gloves

- A rigger style leather palm providing protection for heavier work

Code: AT58903



PVC Gloves With Knitted Wrists

- A knit wrist style glove with resistance to oil, grease and most household chemicals
- Resistance to tears, punctures and abrasions
- Knitted wristband protects against dust infiltration

8 1/2 - **Code: AT58905**

9 1/2 - **Code: AT58906**



Vitrex Thermal Grip Gloves

- Specifically designed for cold weather wear in construction trade
- Maintains gripping capability
- Durable-tear/puncture resistant
- Washable with latex coated palm for non-slip grip

Code: 4602T302111



Vitrex Latex Grip Gloves

- Washable glove with latex coated palm for non-slip grip
- Ideal for various building projects and for handling rough materials such as bricks, slabs etc
- Durable with excellent resistance to tearing, puncture and abrasion
- Contour design and elasticated wrist for close, comfortable fit

Code: 4601T312106



Irwin Fingerless Carpenters Gloves

- Design allows better dexterity
 - Reinforced thumb, palm and fingertips
- Large - **Code: 3820T10503828**
X Large - **Code: 3820T10503829**



Irwin General Construction Gloves

- Fleece lined breathable fabric
 - Reinforced thumb, palm and fingertips
- Large - **Code: 3820T10503822**
X Large - **Code: 3820T10503823**



Irwin Pro -I Gel Knee Pads

- Adjustable sizing pads
 - Non-marking protects surfaces
 - Cap made from non-stick materials
 - Double straps do not restrict blood flow during use
- Code: 3820T10503830**



Irwin Pro All Terrain Knee Pads

- Adjustable sizing pads
- Non-marking protects surfaces
- Wide body keeps stance more stable on uneven surfaces

Code: 3820T10503831



Irwin Professional Swivel Flex Knee Pads

- Adjustable sizing pads
 - Non-marking protects surfaces
 - Convex cap design provides better pivoting and less resistance, giving greater manoeuvrability across textured surfaces such as carpet
- Code: 3820T10503832**



Vitrex Heavy Duty Knee Pads

- Durable waterproof lightweight foam
 - Elasticated strap
 - Thick soft breathable padding
- Code: 4602T302459**



Vitrex Contractors Knee Pads

- Rigid nylon shell with removable inner padding
 - Elasticated strap
 - Suitable for extended use
- Code: 4602T302463**



Nailers G1Gel Swivel Knee Pad

- 7 layers
 - Hardswivel cap
 - Air injected gel core
- Code: 4661TG1**



SAFETY WEAR



Tomcat Orlando TC35C

• Sizes 6-12

Code: ATTC35C __ (Size)



Tomcat Nebraska TC80

- Full grain leather upper
- Composite toe cap & midsole
- Sizes 3-12

Code: ATTC80 __ (Size)



Tomcat Idaho TC90

- Full grain leather upper
- Composite toe cap & midsole
- Sizes 3-12

Code: ATTC90 __ (Size)



Tomcat Graphite TC4300

- Waterproof & Breathable Membrane Safety Hiker Style
- Sizes 6-12

Code: ATTC430 __ (Size)



Tomcat Ashstone TC4100

- Fully Waterproof & Breathable membrane
- Sizes 6-12

Code: ATTC410 __ (Size)



Tomcat Colorado TC30A

- Steel toe-cap and midsole
- Sports cushioned collar
- Sizes 6-12

Code: ATTC30A __ (Size)



Vixen AMETHYST VX900C Honey

- Supple water repellent leather and superior nubuck leather uppers offer extreme comfort
- Composite toe and midsole
- Padded collar for additional ankle support
- Half welted rubber outsole for durability
- Lightweight boot ideal for construction and industrial use
- Sizes 3-8

Code: ATVX900C __ (Size)



Vixen Jasmine VX800B

- Supple nubuck leather upper
- Composite toe and midsole
- Cutaway ankle offering a superb fit
- Vibram rubber anti-fatigue outsole for durability and comfort
- Extremely lightweight
- Sizes 3-8

Code: ATVX800A __ (Size)



Ladies



SAFETY WEAR

Pro Man PM100

- Genuine leather upper
- Sports padded collar and tongue
- Steel toe-cap and midsole
- Textile lining
- Lightweight PU/PU outsole
- Sizes 3-13

Code: ATPM100 __ (Size)



Pro Man PM4009A

- Genuine leather upper
- Padded ankle with cut out Y collar for comfort and ergonomic fit
- Steel toe-cap and midsole
- Textile lining
- Lightweight PU/PU outsole
- Sizes 6-12

Code: ATPM4009A __ (Size)



Pro Man PM4030

- Genuine leather upper with brushed rubber scuff cap
- Shaped collar for additional comfort
- Steel toe-cap and midsole
- Textile lining
- Lightweight and flexible PU/PU outsole
- Rust resistant eyelets
- Sizes 6-12

Code: ATPM4030 __ (Size)



Rock Fall Summit

- Deluxe quality Nubuck
- Rubber outsole
- Anti-fatigue footbed
- Anti scuff heel and toe area
- Steel toe and midsole
- Sizes 6-12

Code: ATSUMMIT __ (Size)



Rock Fall Peak

- Deluxe quality Nubuck
- Rubber outsole
- Anti-fatigue footbed
- Steel toe and midsole
- Sizes 6-12

Code: ATPEAK __ (Size)



Rock Fall Kinder

- Premium quality leather
- Vibram outsole
- Steel toe and midsole
- Sizes 6-12

Code: ATKINDER __ (Size)



Tan Leather Rigger Boots

- Conforms to S2004 - CE EN20345SIP specification
- Fur lined antistatic
- Cushion insole
- Steel midsole and toecap

- Size 6 (39) - **Code: AT58100**
- Size 7 (40) - **Code: AT58101**
- Size 8 (42) - **Code: AT58102**
- Size 9 (43) - **Code: AT58103**
- Size 10 (44) - **Code: AT58104**
- Size 11 (46) - **Code: AT58105**
- Size 12 (47) - **Code: AT58106**



Hardman First Aid Kit

- All medical devices contained within this kit are CE marked
- Workplace packs contain: dressings, plasters, bandages, foil blankets, tape, wipes, gloves & face shield

- Small Workplace First Aid Kit - **Code: AT60366**
- Medium Workplace First Aid Kit - **Code: AT60380**
- Large Workplace First Aid Kit - **Code: AT60384**
- Travel First Aid Kit - **Code: AT60684**



SAFETY WEAR



Hardman Hi-Vis Highway Jacket

M - Code: AT58010
L - Code: AT58011
XL - Code: AT58012
XXL - Code: AT58013



Hardman Hi-Vis Polo Shirt

M - Code: AT58037
L - Code: AT58038
XL - Code: AT58039
XXL - Code: AT58040



Hardman Hi-Vis Waistcoat

M - Code: AT58014
L - Code: AT58015
XL - Code: AT58015A
XXL - Code: AT58015B



Hardman Hi-Vis Bomber Jacket

M - Code: AT58029
L - Code: AT58028
XL - Code: AT58027
XXL - Code: AT58026



SKIN HYGIENE CENTRE

STEP 1



Cleanse

Wash your hands regularly with the appropriate hand cleaner



STEP 2



Sanitise

Use without water to kill germs and provide a higher level of hand hygiene



STEP 3



Restore

Apply to clean hands after work to re-condition your skin



Stanley Fatmax Screwdrivers



⊕ Philips

Code	Bar Length	Type
2685T065206	75mm	PH0
2685T065207	100mm	PH1
2685T065208	250mm	PH1
2685T065209	125mm	PH2
2685T065224	250mm	PH2
2685T065316	150mm	PH3

⊕ Torx

Code	Bar Length	Type
2685T065340	75mm	TT10
2685T065395	75mm	TT15
2685T065396	100mm	TT20
2685T065397	100mm	TT25
2685T065398	125mm	TT30
2685T065399	125mm	TT40



SCREWDRIVERS

⊖ Parallel Tip

Code	Bar Length	Bar Width
2685T065008	100mm	3mm
2685T065017	100mm	4mm
2685T065093	150mm	4mm
2685T065094	150mm	5.5mm

⊕ Pozi

Code	Bar Length	Type
2685T065319	75mm	PZ0
2685T065335	100mm	PZ1
2685T065336	250mm	PZ1
2685T065337	125mm	PZ2
2685T062571	250mm	PZ2
2685T065338	150mm	PZ3
2685T065339	200mm	PZ4

PZ2 30mm Stubby - Code: **2685T065409**

⊖ Flared Tip

Code	Bar Length	Bar Width
2685T065016	100mm	4mm
2685T065098	100mm	5.5mm
2685T065141	150mm	6.5mm
2685T065137	150mm	8mm
2685T065138	175mm	8mm
2685T065139	200mm	10mm
2685T065143	250mm	12mm

SCREWDRIVERS

STANLEY
FatMax

Stanley Fatmax 12 Piece Parallel/Flared/Philips/Pozi Screwdriver Set

Set Contains:

- Parallel 2.5mm x 50mm, 4mm x 100mm, 5.5mm x 150mm, 6.5mm x 30mm
- Flared 5.5mm x 100mm, 8mm x 150mm
- Phillips PH0 x 75mm, PH1 x 100mm, PH2 x 125mm
- Pozi PZO x 75mm, PZ1 x 100mm, PZ2 x 125mm

Code: 2500T565426



Stanley Fatmax 9 Piece Parallel/Flared/Pozi Screwdriver Set

Set Contains:

- Parallel 3mm x 50mm, 4mm x 100mm, 6.5mm x 30mm
- Flared 5.5mm x 100mm, 6.5mm x 150mm, 8mm x 150mm
- Pozi PZO x 75mm, PZ1 x 100mm, PZ2 x 125mm

Code: 2685T565424



Stanley Cushion Grip 10 Piece Flared/Pozi Set

Set Contains:

- Flared Instrument 3mm x 75mm, 5mm x 100mm, 6.5mm x 45mm, 6.5mm x 150mm, 8mm x 150mm
- Pozi Instrument PZO x 60mm, PZ1 x 75mm, PZ2 x 45mm, PZ2 x 100mm, PZ3 x 150mm

Code: 2685T265014



Stanley 6 Way Screwdriver

- All in one screwdriver
- Built in bolster allows additional leverage
- Supplied with Phillips 1 and 2, 2 x slotted and 2 nut drivers (1/4" and 5/16")
- Tri lobular bi-material handle for torque and comfortable grip

Set Contains:

- Hex drive 6mm, 8mm
- Parallel 4.5mm, 6mm
- Phillips PH1, PH2

Code: 2694T068012



Stanley Multi Bit Ratchet Screwdriver

- Magnetic head for efficient hold and rapid changing of the bit
- Bit storage cartridge for easy access
- Tri-lobular bi-material handle for maximum torque comfort
- 3 position Ratchet enables clockwise, counter clockwise and locked ratcheting positions
- Supplied with 10 insert bits of popular sizes

Code: 2689T068010



Stanley Fatmax Xtreme Multi-Bit Ratchet Screwdriver

- Fine 45 tooth ratchet mechanism 8° increments for fast tightening
- 3 position ratchet enables clockwise, counter clockwise and locked ratcheting positions
- Mechanical and magnetic bit retention
- Tri-material handles for comfort
- Includes 15 chrome vanadium bits
- Slotted 3mm, 4.5mm x 2, 6mm
- Phillips PH1, PH2 x 2, PH3
- Pozi PZ1, PZ2, 2 x PZ3
- Torx T15, T20, T25

Code: 2689T069191

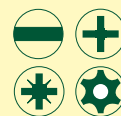

Hardman 6 Piece Screwdriver Set

Set Contains:

- 5.5 x 100mm Flared
- 6 x 150mm Flared
- 8 x 150mm Flared
- 3 x 100mm Parallel*
- PZ1 x 75mm
- PZ2 x 100mm



- Complete with hex bolster (* no bolster)
- Chrome vanadium hardened blades
- Ergonomic soft grip handle for comfortable use

Code: AT01050



Hardman 6 Piece VDE Screwdriver Set

Set Contains:

- 3 x 75mm Slotted
- 5.5 x 125mm Slotted
- 6.5 x 150mm Slotted
- PH1 x 80mm
- PH2 x 100mm
- GS Tester



- Certified to Din EN 60900
- For use up to 1000V a.c and 1500V d.c

Code: AT01060



Hardman Screwdrivers

- Chrome vanadium hardened blades
- Ergonomic soft grip handle for comfortable use
- c/w Hex Bolster

Slotted

Code	Description
AT01000	5.5 x 100mm
AT01001	6 x 150mm
AT01002	8 x 150mm
AT01003	8 x 200mm
AT01004	10 x 250mm
AT01010	3 x 100mm *
AT01011	3 x 150mm *

Pozi

Code	Description
AT01020	PZ0 x 60mm
AT01021	PZ1 x 75mm
AT01022	PZ2 x 100mm
AT01023	PZ3 x 150mm
AT01024	PZ1 x 250mm
AT01025	PZ2 x 250mm

Phillips

AT01030 PH1 x 75mm



* No Bolster

Unior VDE Screwdriver Set

- 6 Piece

Code: 6042TSET



Unior Large Mains Testers

Code: 6047TLARGE



Unior Small Mains Testers

Code: 6047TSMALL



SCREWDRIVERS

STANLEY[®]

Stanley 10 Piece Hex Bit Set

- 9 Insert bits and a bit holder in a plastic storage box
- Precision machined for perfect fit
- Forged and ground for long life and durability

Set Contains:

- Phillips PH2
- Pozi PZ1, PZ2, PZ3
- Torx T10, T15, T20, T25, T30
- Magnetic Bit Holder

Code: 2723T168724



Stanley 1/4" Hex Drive Phillips Power Bit

- For industrial use
- Precision machined for perfect fit
- Forged and ground for long life and durability
- 50mm/PH2

Code: 2721T168992



Stanley 1/4" Hex Drive Pozi Power Bit

- For industrial use
- Precision machined for perfect fit
- Forged and ground for long life and durability
- 70mm/PZ2 - Code: 2725TNO020070
- 100mm/PZ2 - Code: 2723T368807



Stanley 7 Piece Bit Set

- 6 Insert bits and a bit holder in a plastic storage box
- Precision machined for perfect fit
- Forged and ground for long life and durability

Set Contains

- Pozi PZ0, PZ1, PZ2
- Flared 0.6 x 4.5mm, 1.0 x 5.5mm, 1.2 x 6.5mm
- Magnetic Bit Holder

Code: 2723T07SP



Stanley 10 Piece Bit Set

- 9 Insert bits and a bit holder in a plastic storage box
- Precision machined for perfect fit
- Forged and ground for long life and durability

Set Contains

- Phillips PH1, PH2, PH3
- Pozi PZ1, PZ2, PZ3
- Parallel 4.5 x 0.6mm, 5.5 x 1.0mm, 6.5 x 1.2mm
- Magnetic Bit Holder

Code: 2723T10SET



Stanley 1/4" Drive Hex Insert Bit

- For use in industrial, construction and DIY applications
- Precision machined for perfect fit
- Forged and ground for long life and durability



Code	Box	Size
2716TNO01	25	25mm/PH1
2716TNO02	25	25mm/PH2
2717T168950	25	25mm/PH3
2723TNO01	25	25mm/PZ1
2500T168949	25	25mm/PZ2
2723TNO03	25	25mm/PZ3



Stanley 1/4" Drive Hex Torx Bit

- For use in industrial, construction and DIY applications
- Precision machined for perfect fit
- Forged and ground for long life and durability



Code	Box	Size
2725T168842	25	T20 Torx
2725T168843	25	T25 Torx
2725T168845	25	T30 Torx



Stanley Magnetic Bit Holders

- 1/4" hex drive spindle will fit most chuck types
- Magnetic recess holds 1/4" insert bits securely in use
- Precision machined for perfect fit
- Forged and ground for long life and durability

60mm - Code: 2726T168732



Stanley Quick Release Magnetic Bit Holder

- Quick release bit holder
- Precision machined for perfect fit
- Forged and ground for long life and durability

Code: 2726T168733



Stanley Fatmax VDE Screwdrivers



The heavy duty plastic sheath running the length of the bar protects the user from live current

Red handles help self selection and identification of a VDE screwdriver

All Stanley VDE screwdrivers are individually tested to 10,000 volts, and guaranteed to 1000 volts

Stanley Fatmax VDE Screwdrivers



Code	Bar Length	Bar Width
2685T065410	50mm	2.5mm
2685T065411	75mm	3.5mm
2685T065412	100mm	4mm
2685T065413	150mm	5.5mm

Code	Bar Length	Type
2685T065417	75mm	Pozi 0
2685T065418	100mm	Pozi 1
2685T065419	125mm	Pozi 2
2685T065414	75mm	PH0
2685T065415	100mm	PH1
2685T065416	125mm	PH2



Stanley Fatmax 10 Piece Parallel/Phillips/Pozi VDE Screwdriver Set

Set Contains:

- Parallel 2.5mm x 50mm, 3.5mm x 75mm, 5.5mm x 150mm
- Phillips PH0 x 75mm, PH1 x 100mm, PH2 x 125mm
- Pozi PZO x 75mm, PZ1 x 100mm, PZ2 x 125mm
- Voltage Tester

Code: 2685T562573



Ask about our extensive range of screwdriver sets from Stanley and other leading manufacturers.

SNIPS & SHEARS



Wiss Multi Purpose Snips

- Blades designed for straight, left and right cuts
- Wear resistant molybdenum steel blades are made to stand up to the tremendous pressures created by the compound lever action
- Compound cutting action allows the cutting of material up to 18 gauge carbon steel
- Non-slip grips provide superior control and comfort

Left & Straight (Red) - **Code: 4793TM1R**
 Right & Straight (Green) - **Code: 4793TM2R**
 Straight & Curved (Yellow) - **Code: 4793TM3R**



Irwin 10" Aviation Snips

- Cold-formed blades are 44% stronger and requires 25% less cutting force
- Easy push-up release allows one-handed operation pro-touch grips
- Provide superior comfort, resists twisting and will not slip off
- Lower serrated blade grips material for a smoother cut with no double marked edges

Right Cut (Green) - **Code: 3567T1000G**
 Straight Cut (Yellow) - **Code: 3567T1000Y**
 Left Cut (Red) - **Code: 3567T1000R**



Stanley Aviation Snips

- Suitable for cutting aluminium, sheet UPVC, wire mesh, leather, copper and plastic
- Cuts up to 18 gauge mild steel 0.7 to 1.2mm
- Made from forged alloy steel for strength and durability
- Double pivot action for high cutting power
- One handed automatic latch release
- Bi-material easy grip handles

250mm Left (Red) - **Code: 2751T214562**
 250mm Straight (Yellow) - **Code: 2751T214563**
 250mm Right (Green) - **Code: 2751T214564**
 300mm Snip/Long Cut - **Code: 2751T214566**



Wiss Offset Snips

- Withstands strain of cutting heavy stock and tight curves
- Handles are formed of high strength steel
- Non-slip serrated jaws of tough molybdenum steel to provide extra service demanded by the compound lever action

Left & Straight (Red) Offset - **Code: 4793TM6R**
 Right & Straight (Green) offset - **Code: 4793TM7R**



Irwin Record

9" Medium Duty Compact Cutter 909

- Suitable for cutting fencing, thin gauge mesh and jointing wire

Code: 3543T0900



Knipex 190mm Wire Rope Cutters

- For medium hard wire up to 6mm diameter eg Bowden cords, but also for cables and steel rods
- With opening spring and locking lever
- Cutting edges additionally induction hardened
- Special blade geometry prevents the wire rope fanning out

Code: 6135T9561190



Irwin Gilbow Heavy Duty Cranked-Handle Shears

- Accurately ground edges that ensure the material being cut does not slip out of the jaws and become damaged
- The hollow ground jaw faces provide a longer life to the cutting edge
- Tinsnips are jointed with a nut and bolt design essential in ensuring the longest possible life of the joint, whilst keeping a good, easy, smooth cutting movement
- Great cutting capability which is much greater than the strength of the user and will provide a good, clean, easy cut edge to any workpiece

667 - 11" L/H Cranked - **Code: 3569T1100L**
 669 - 11" R/H Cranked - **Code: 3569T1100**
 6691 - 14" R/H Cranked - **Code: 3569T1400**

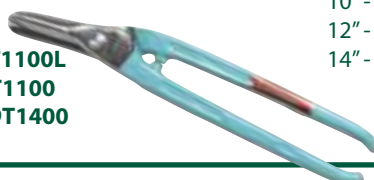

Irwin Gilbow General Purpose Snips 6245

- Jointed with a nut and bolt design essential in ensuring the longest possible life of the joint, whilst keeping a good easy smooth cutting movement
- Cutting capability much greater than the strength of the user
- The original tin snips were first designed in 1924 and have dominated the sheet metal cutting industry to such an extent that today, snips and shears are referred to as Gilbows

8" - **Code: 3563T0800**
 10" - **Code: 3563T1000**
 12" - **Code: 3563T1200**
 14" - **Code: 3563T1400**



Carolus 1/2" Sq Drive Reversible Ratchet

- With lever change
- Oval head
- Dual-material handle, for easy handling
- Weight: 580g
- Length: 280mm

Code: 4985T012RR



Unior 1/2" Sq Drive Reversible Ratchet

- Ergonomic heavy duty double component handle
- 75 - teeth
- Body drop forged
- Entirely hardened and tempered

Code: 6003T611782



Carolus 1/2" Sq Drive Sliding T Handle

- Tommy bar with sliding T 1/2"
- For hand-operated sockets with square drive, with ball locking device
- Weight: 380g

Code: 4985T012TB



Unior 1/2" Sq Drive Sliding T Handle

- Material: chrome vanadium
- Chrome plated according to EN12540
- Made according to standard ISO 3315
- Entirely hardened and tempered

Code: 6003T1903



Carolus 1/2" Sq Drive Extension

- For hand-operated sockets with square drive, with ball locking device
- 75mm - **Code: 4985T012E75**
- 125mm - **Code: 4985T012E125**
- 250mm - **Code: 4985T012E250**



Unior 1/2" Sq Drive Extension

- Material: chrome vanadium
- Chrome plated according to EN12540
- Made according to standard ISO 3315
- Polished head
- Drop forged, entirely hardened and tempered
- 125mm - **Code: 6003T1905**
- 250mm - **Code: 6003T1904**



Carolus 1/2" Sq Drive Universal Joint

- For hand-operated sockets with square drive, with ball locking device

Code: 4985T012UJ



Unior 1/2" Sq Drive Universal Joint

- Material: chrome vanadium
- Chrome plated according to EN12540
- Made according to standard ISO 3315
- Drop forged, entirely hardened and tempered

Code: 6003T1906



SOCKETS 1/2" SQUARE DRIVE



Carolus 1/2" Sq Drive Bi-Hex Socket

- Square drive as per DIN 3120 - C 12.5, ISO 1174, with ball retention groove



Code	Size
4986T01208	8mm
4986T01209	9mm
4986T01210	10mm
4986T01211	11mm
4986T01212	12mm
4986T01213	13mm
4986T01214	14mm
4986T01215	15mm
4986T01216	16mm
4986T01217	17mm
4986T01218	18mm
4986T01219	19mm
4986T01220	20mm
4986T01221	21mm
4986T01222	22mm
4986T01223	23mm
4986T01224	24mm
4986T01227	27mm
4986T01228	28mm
4986T01230	30mm
4986T01232	32mm

Unior 1/2" Sq Drive Swivel Handle

- Material: chrome molybdenum
- Ergonomic heavy duty double component handle
- Body drop forged
- Chrome plated to standard EN 12540
- Made according to standard ISO 3315
- Entirely hardened and tempered

380mm - Code: **6003T611899**
 450mm - Code: **6003T611900**



Unior 1/2" Sq Drive Hex Socket

- Chrome plated according to EN12540
- Drop forged, entirely hardened and tempered
- Made according to standard ISO 2725-1



Code	Size
6003T56	10mm
6003T57	11mm
6003T58	12mm
6003T59	13mm
6003T60	14mm
6003T62	16mm
6003T83	17mm
6003T63	18mm
6003T84	19mm
6003T64	20mm
6003T645	21mm
6003T65	22mm
6003T655	23mm
6003T66	24mm
6003T675	26mm
6003T68	27mm
6003T69	30mm
6003T692	32mm



Carolus

1/2" Sq Drive Deep Hex Socket

- Square drive as per DIN 3120 - C 12.5, ISO 1174, with ball retention groove



Code	Size
4985T01210L	10mm
4985T01211L	11mm
4985T01212L	12mm
4985T01213L	13mm
4985T01214L	14mm
4985T01215L	15mm
4985T01216L	16mm
4985T01217L	17mm
4985T01218L	18mm
4985T01219L	19mm
4985T01222L	22mm
4985T01224L	24mm
4985T01227L	27mm

Unior

1/2" Sq Drive Long Type Hex Socket

- Polished chrome plated surface finish
- Drop forged, entirely hardened and tempered



Code	Size
6003T610762	10mm
6003T610763	11mm
6003T610765	13mm
6003T610767	15mm
6003T610768	16mm
6003T610769	17mm
6003T610770	18mm
6003T610771	19mm
6003T610773	21mm
6003T610774	22mm
6003T610776	24mm
6003T610777	27mm
6003T610778	30mm
6003T610779	32mm

METAL MATE®



At METALMATE® we make sure every HT bolt/set, every socket screw and every fastener in the METALMATE® range reaches and maintains the same high quality standard everytime.

We ensure consistent quality by tracking the materials used at each stage of the manufacturing and packing process, from start to finish - from Steel billets in the Far East, to our stocked product in the UK.

- Available from stock next day, with no MOQ
- Sourced from audited qualified suppliers
- Full batch traceability to source
- Extensive competitive ranges
- 3.1b certification

SOCKETS 1/2" SQUARE DRIVE



Carolus

1/2" Sq Drive In-Hex Bit Socket

- Carolus 5135 screwdriver bit socket 1/2" In-Hex
- Square drive as per DIN 3120 - C 12.5, ISO 1174, with ball retention groove



Code	Size
4987T01204L	4mm
4987T01205L	5mm
4987T01206L	6mm
4987T01207L	7mm
4987T01208L	8mm
4987T01210L	10mm
4987T01214L	14mm
4987T01217L	17mm
4987T01219L	19mm

Unior 1/2" Sq Drive Hex Bit Socket

- Material: socket: chrome plated, polished
- Material: bit: special tool steel, anticorrosive oiled
- Entirely hardened and tempered



Code	Size
6004T45	4mm
6004T47	5mm
6004T49	6mm
6004T52	7mm
6004T54	8mm
6004T55	9mm
6004T56	10mm
6004T58	12mm
6004T60	14mm
6004T83	17mm
6004T84	19mm

Unior 1/2" Sq Drive Hex Bit Socket Set

- 9 pieces in set
- 5-17mm

Code: 6004T19214



For our range of Chisels go to page 186



Carolus 1/2" Sq Drive Impact Socket

- Square drive as per DIN 3121 - G 12.5, ISO 1174



Code	Size
4988T01210	10mm
4988T01211	11mm
4988T01212	12mm
4988T01213	13mm
4988T01214	14mm
4988T01215	15mm
4988T01216	16mm
4988T01217	17mm
4988T01219	19mm
4988T01221	21mm
4988T01222	22mm
4988T01224	24mm
4988T01227	27mm
4988T01230	30mm
4988T01232	32mm

Unior 1/2" Sq Drive Impact Socket

- Chrome molybdenum
- Surface finish: phosphated to standard DIN 12476
- Drop forged, entirely hardened and tempered



Code	Size
6003T603962	10mm
6003T603964	12mm
6003T603965	13mm
6003T603966	14mm
6003T603967	15mm
6003T603968	16mm
6003T603969	17mm
6003T603970	19mm
6003T603971	21mm
6003T603972	22mm
6003T603974	24mm
6003T603975	27mm
6003T603976	30mm

Unior 1/2" Sq Drive Impact Extension

- Material: chrome molybdenum
- Surface finish: phosphated to standard DIN 12476
- Drop forged, entirely hardened and tempered
- 125mm

Code: 6003T603977



Unior 1/2" Sq Drive Impact Universal Joint

- Material: chrome molybdenum
- Surface finish: phosphated to standard DIN 12476
- Drop forged, entirely hardened and tempered

Code: 6003T609460



SOCKETS 1/4" SQUARE DRIVE



Carolus 1/4" Sq Drive Reversible Ratchet

- With lever change
- Sturdy design
- Oval head
- Dual-material handle, for easy handling
- For sockets, accessories etc
- With square drive as per DIN 3120 - C 6.3, ISO 1174, with ball retention groove

Code: 4985T014RR



Unior 1/4" Sq Drive Reversible Ratchet

- Ergonomic heavy duty double component handle
- With 40 - teeth
- Body drop forged
- Entirely hardened and tempered
- Surface finish: chrome plated to standard EN 12540
- Made according to standard ISO 3315

Code: 6003T611901



Carolus 1/4" Sq Drive Sliding T Handle

- Tommy bar with sliding T 1/4"
- For hand-operated sockets with square drive, with ball locking device

Code: 4985T014TB



Unior 1/4" Sq Drive Sliding T Handle

- Material: chrome vanadium
- Chrome plated according to EN12540
- Made according to standard ISO 3315
- Entirely hardened and tempered

Code: 6003T600830



Carolus 1/4" Sq Drive Extension

- For hand-operated sockets with square drive

50mm - **Code: 4985T014E50**
100mm - **Code: 4985T014E100**



Unior 1/4" Sq Drive Extension Bar

- Material: chrome vanadium
- Chrome plated according to EN12540
- Made according to standard ISO 3316
- Drop forged, entirely hardened and tempered

50mm - **Code: 6003T600826**
150mm - **Code: 6003T600827**



Carolus 1/4" Sq Drive Universal Joint

- For hand-operated sockets with square drive, with ball locking device

Code: 4985T014UJ



Unior 1/4" Sq Drive Universal Joint

- Material: chrome vanadium
- Chrome plated according to EN12540
- Made according to standard ISO 3316
- Drop forged, entirely hardened and tempered

Code: 6003T607821



Carolus 1/4" Sq Drive Hex Socket

- Square drive as per DIN 3120 - C 6.3, ISO 1174, with ball retention groove

Code	Size
4985T01403	3mm
4985T01404	4mm
4985T014045	4.5mm
4985T01405	5mm
4985T014055	5.5mm
4985T01406	6mm
4985T01407	7mm
4985T01408	8mm
4985T01409	9mm
4985T01410	10mm
4985T01411	11mm
4985T01412	12mm
4985T01413	13mm
4985T01414	14mm



Unior 1/4" Sq Drive Hex Socket

- Surface finish: chrome plated according to EN12540
- Drop forged, entirely hardened and tempered

Code	Size
6003T600815	4mm
6003T600816	4.5mm
6003T600817	5mm
6003T600818	5.5mm
6003T600819	6mm
6003T600820	7mm
6003T600821	8mm
6003T600822	9mm
6003T600823	10mm
6003T600824	11mm
6003T600825	13mm



Carolus 1/4" Sq Drive Deep Hex Socket

- Square drive as per DIN 3120 - C 6.3, ISO 1174, with ball retention groove

Code	Size
4985T01404L	4mm
4985T01445L	4.5mm
4985T01405L	5mm
4985T014055L	5.5mm
4985T01406L	6mm
4985T01407L	7mm
4985T01408L	8mm
4985T01409L	9mm
4985T01410L	10mm
4985T01411L	11mm
4985T01412L	12mm



Unior 1/4" Sq Drive Hex Bit Socket

- Material: socket: chrome molybdenum, chrome plated
- Material: bit: special tool steel, anticorrosive oiled
- Made according to standard DIN 7422
- Entirely hardened and tempered

Code	Size
6004T607898	3mm
6004T607899	4mm
6004T607900	5mm
6004T607901	6mm
6004T607902	7mm



SOCKETS 3/8" SQUARE DRIVE



Carolus 3/8" Sq Drive Reversible Ratchet

- With lever change
- Sturdy design
- Oval head
- Dual-material handle, for easy handling
- For sockets, accessories etc
- With square drive as per DIN 3120 - C 10, ISO 1174, with ball retention groove

Code: 4985T038RR



Unior 3/8" Sq Drive Reversible Ratchet

- Ergonomic heavy duty double component handle
- 75 - teeth
- Body drop forged
- Entirely hardened and tempered
- Chrome plated to standard EN 12540
- Made according to standard ISO 3315
- 200mm

Code: 6025T612501



Unior 3/8" Sq Drive Sliding T Handle

- Surface finish: chrome plated according to EN 12540
- Polished head
- Made according to standard ISO 3315
- Entirely hardened and tempered

Code: 6003T605341



Unior 3/8" Sq Drive Swivel Handle

- Ergonomic heavy duty double component handle
- Body drop forged
- Chrome plated to standard EN 12540
- Made according to standard ISO 3315
- Entirely hardened and tempered

Code: 6003T605341



Carolus 3/8" Sq Drive Extension

- For hand-operated sockets with square drive

125mm - **Code: 4985T038E128**

150mm - **Code: 4985T038E150**



Unior 3/8" Sq Drive Extension Bar

- Material: chrome vanadium
- Chrome plated according to EN12540
- Polished head
- Made according to standard ISO 3316
- Drop forged, entirely hardened and tempered

125mm - **Code: 6003T605343**

250mm - **Code: 6003T605342**



Carolus 3/8" Sq Drive Universal Joint

- For hand-operated sockets with square drive, with ball locking device

Code: 4985T038UJ



Unior 3/8" Sq Drive Universal Joint

- Material: chrome vanadium
- Chrome plated according to EN12540
- Made according to standard ISO 3316
- Drop forged, entirely hardened and tempered

Code: 6003T605344



Carolus 3/8" Sq Drive Hex Socket

- Square drive as per DIN 3120 - C 6.3, ISO 1174, with ball retention groove



Code	Size
4985T03806	6mm
4985T03807	7mm
4985T03808	8mm
4985T03809	9mm
4985T03810	10mm
4985T03811	11mm
4985T03812	12mm
4985T03813	13mm
4985T03814	14mm
4985T03815	15mm
4985T03816	16mm
4985T03817	17mm
4985T03818	18mm
4985T03819	19mm
4985T03820	20mm
4985T03821	21mm
4985T03822	22mm
4985T03824	24mm

Unior 3/8" Sq Drive Hex Socket

- Surface finish: chrome plated according to EN12540
- Drop forged, entirely hardened and tempered



Code	Size
6003T605322	6mm
6003T605325	9mm
6003T605327	11mm
6003T605330	14mm
6003T605333	17mm
6003T605334	18mm
6003T605335	19mm
6003T605336	20mm
6003T605337	21mm
6003T605338	22mm

For our range of Handsaws
go to page 53



SOCKETS 3/4" SQUARE DRIVE



Carolus 3/4" Sq Drive Reversible Ratchet

- With lever change
- Sturdy design
- Oval head

Code: 4985T034R



Unior 3/4" Sq Drive Reversible Ratchet

- Material: special tool steel
- Body drop forged
- Entirely hardened and tempered
- Surface finish: chrome plated to standard EN 12540
- Made according to standard ISO 3315

Code: 6003T602737



Carolus 3/4" Sq Drive Sliding T Handle

- Tommy bar with sliding T 3/4"
- For hand-operated sockets with square drive, with locking pin

Code: 4985T034TB



Unior 3/4" Sq Drive Sliding T Handle

- Chrome plated according to EN 12540
- Polished head
- Made according to standard ISO 3315
- Entirely hardened and tempered

Code: 6003T602738



Carolus 3/4" Sq Drive Extension

- Extension 3/4", 400mm long
- For hand-operated sockets with square drive, with locking pin

Code: 4985T034E400



Unior 3/4" Sq Drive Extension

- Material: chrome vanadium
- Surface finish: chrome plated according to EN 12540
- Polished head
- Drop forged, entirely hardened and tempered
- Made according to standard ISO 3316

205mm - Code: 6003T602740

405mm - Code: 6003T602739



Carolus 3/4" Sq Drive Universal Joint

- For hand-operated sockets with square drive, with locking pin

Code: 4985T034UJ



Unior 3/4" Sq Drive Universal Joint

- Material: chrome vanadium
- Surface finish: chrome plated according to EN 12540
- Drop forged, entirely hardened and tempered
- Made according to standard ISO 3316

Code: 6003T617657



Carolus 3/4" Sq Drive Hex Socket

- Female square drive, with ball retaining groove
- Hand-operated, knurled grip



Code	Size
4985T03436	36mm
4985T03438	38mm
4985T03441	41mm
4985T03446	46mm
4985T03450	50mm
4985T03455	55mm
4985T03460	60mm

Unior 3/4" Sq Drive Hex Socket

- Material: chrome molybdenum
- Surface finish: chrome plated according to EN 12540
- Polished
- Torque: DIN 899 range E
- Drop forged, entirely hardened and tempered
- Made according to standard ISO 2725-1



Code	Size
6043T602734	41mm
6043T602735	46mm
6043T602736	50mm
6043T603135	60mm

Unior 3/4" Sq Drive Impact Extension

- Material: chrome molybdenum
- Surface finish: phosphated to standard DIN 12476
- Drop forged, entirely hardened and tempered

175mm - Code: **6003T603993**

250mm - Code: **6003T603992**



Unior 3/4" Sq Drive Impact Socket

- Material: chrome molybdenum
- Surface finish: phosphated to standard DIN 12476
- Drop forged, entirely hardened and tempered
- Made according to standard ISO 2725-2



Code	Size (Length)
6003T603980	17mm
6003T603981	19mm
6003T603982	21mm
6003T603983	22mm
6003T603984	24mm
6003T603985	27mm
6003T603986	30mm
6003T603987	32mm
6003T603989	36mm
6003T603990	41mm
6003T603991	46mm

Please contact us for our seasonal offers such as Rock Salt, Gardening and De-icer.



SOCKETS 1" SQUARE DRIVE



Carolus 1" Sq Drive Reversible Ratchet

- Ratchet handle with coupler 1"
- With square coupler, medium-fine toothed, extremely rugged
- Push-fit tube handle
- For hand-operated sockets and accessories with square drive as per DIN 3120 - D 25, ISO 1174 with locking pin
- GEDORE vanadium steel 31CrV3, chrome-plated

Code: 4985T100R

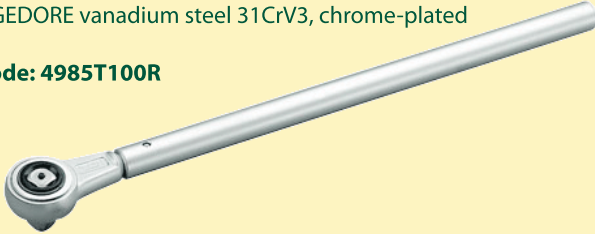

Unior 1" Sq Drive Reversible Ratchet

- Material: special tool steel
- Body drop forged
- Entirely hardened and tempered
- Surface finish: chrome plated to standard EN 12540
- Made according to standard ISO 3315

Code: 6003T603104



Carolus 1" Sq Drive Sliding T Handle

- For hand-operated, sockets with square drive as per DIN 3120, ISO 1174, with locking pin

Code: 4985T100TB



Unior 1" Sq Drive Sliding T Handle

- Chrome plated according to EN 12540
- Polished head
- Made according to standard ISO 3315
- Entirely hardened and tempered

Code: 6003T603105



Carolus 1" Sq Drive Extension

- For hand-operated sockets with square drive as per DIN 3120, ISO 1174, with locking pin
- 200mm

Code: 4985T100E200



Unior 1" Sq Drive Extension Bar

- Chrome plated according to EN 12540
- Polished head
- Made according to standard ISO 3316
- Entirely hardened and tempered

200mm - Code: 6003T603107
400mm - Code: 6003T603106



Carolus 1" Sq Drive Universal Joint

- For hand-operated sockets with square drive as per DIN 3120, ISO 1174, with locking pin

Code: 4985R100UJ



Unior 1" Sq Drive Impact Universal Joint

- Material: chrome molybdenum
- Surface finish: phosphated to standard DIN 12476
- Drop forged, entirely hardened and tempered

Code: 6003T615216



Carolus 1" Sq Drive Bi Hex Socket

- Square drive as per DIN 3120 - D 25, ISO 1174, with locking pin
- Hand-operated, knurled grip



Code	Size
4985T10036	36mm
4985T10041	41mm
4985T10046	46mm
4985T10050	50mm
4985T10055	55mm
4985T10060	60mm
4985T10065	65mm
4985T10070	70mm
4985T10075	75mm
4985T10080	80mm

Unior 1" Sq Drive Hex Socket

- Material: chrome molybdenum
- Surface finish: chrome plated according to EN 12540
- Polished
- Drop forged, entirely hardened and tempered
- Made according to standard ISO 2725-1



Code	Size
6003T603097	50mm
6003T603098	55mm
6003T603099	60mm
6003T603100	65mm
6003T603101	70mm
6003T603102	75mm
6003T603103	80mm

Unior 3/8" Male To 1/4" Female Adaptor

- Material: chrome vanadium
- Drop forged, entirely hardened and tempered
- Surface finish: chrome plated to standard EN 12540
- Made according to standard ISO 3316

Code: 6003T607976



Unior 3/8" Female To 1/4" Male Adaptor

- Material: chrome vanadium
- Drop forged, entirely hardened and tempered
- Polished head
- Surface finish: chrome plated to standard EN 12540
- Made according to standard ISO 3316

Code: 6003T607977



Unior 1/2" Female To 3/8" Male Adaptor

- Material: chrome vanadium
- Drop forged, entirely hardened and tempered
- Surface finish: chrome plated to standard EN 12540
- Made according to standard ISO 3316

Code: 6003T603334



Unior 3/8" F To 1/2" M Socket Adaptor

- Material: chrome vanadium
- Drop forged, entirely hardened and tempered
- Surface finish: chrome plated to standard EN 12540
- Made according to standard ISO 3316

Code: 6003T605345



Unior 3/4" Female To 1/2" Drive Adaptor

- Material: chrome vanadium
- Drop forged, entirely hardened and tempered
- Polished head
- Surface finish: chrome plated to standard EN 12540
- Made according to standard ISO 3316

Code: 6003T602741



Unior 1/2" Female To 3/4" Male Adaptor

- Material: chrome vanadium
- Drop forged, entirely hardened and tempered
- Surface finish: chrome plated to standard EN 12540
- Made according to standard ISO 3316

Code: 6003T607975



SOCKET SETS



Bahco SL25

1/4" Drive Socket Set

- 25 piece set
- 1/4" socket set
- High performance alloy steel
- Case: high density polythene
- Matt finish

Code: 6295TSL25



Bahco S460

1/4" Drive Socket Set

- 46 piece set
- 1/4" socket set
- Matt finish
- Case: high density polythene

Code: 6295TS460



Bahco S160

1/4" Sq Drive Socket Set

- 16 piece set
- 1/4" socket set
- High performance alloy steel
- Case: high density polythene
- Matt finish

Code: 6295TS160



Bahco S330

1/4" & 3/8" Socket Set

- 33 piece set
- 1/4" and 3/8" socket set
- High performance alloy steel
- Case: high density polythene
- Matt finish

Code: 6295TS330



Bahco S910/AF

1/4" & 1/2" Drive Socket Set

- 91 piece set
- 1/4" and 1/2" sockets, and combination spanners set
- High performance alloy steel
- Case: high density polythene
- Matt finish
- Metric - **Code: 6295TS910**
- Imp - **Code: 6295TS910AF**



Bahco S800

1/4" & 1/2" Drive Socket Set

- 77 piece set
- 1/4" and 1/2" socket set
- Chrome vanadium socket set

Code: 6295TS800



Bahco S560 1/4" & 1/2" Sq Drive Socket Set

- 56 piece set
- 1/4" and 1/2" socket set
- High performance alloy steel
- Case: high density polythene
- Matt finish

Code: 6295TS560



Bahco S410 1/4" & 1/2" Sq Drive Socket Set

- 41 piece set
- 1/4" and 1/2" socket, and combination spanners set
- High performance alloy steel
- Case: high density polythene
- Matt finish

Code: 6295TS410



Bahco S380

3/8" Sq Drive Socket Set

- 38 piece set
- 3/8" socket set
- High performance alloy steel
- Case: high density polythene
- Matt finish

Code: 6295TS380



Bahco S400 1/2" Sq Drive Socket & Spanner Set

- 40 piece set
- 1/2" socket & combination spanner set
- High performance alloy steel
- Case: high density polythene
- Matt finish

Code: 6295TS400



Bahco S240 Sq Drive Socket Set

- 24 piece set
- 1/2" socket set
- High performance alloy steel
- Case: high density polythene
- Matt finish

Code: 6295TS240



Bahco S87+7 Socket Set

- 94 piece set
- 1/4" & 1/2" sockets, and combination spanner set
- High performance alloy steel
- Case: high density polythene
- Matt finish

Code: 6295TS87PLUS7





SOCKET SETS

Bahco S106 Combi Wrench and 1/4" & 1/2" Sq Drive Socket Set

- 106 piece set
 - 1/2" & 1/4" sockets, and combination spanners set
 - High performance alloy steel
 - Case: high density polythene
 - Matt finish
- Code: 6295TS106**



Bahco SLX17 3/4" Sq Drive Socket Set

- 17 piece set
 - 3/4" socket set
 - High performance alloy steel
 - Case: high density polythene
 - Matt finish
- Code: 6295TSLX17**



Carolus 41 Pce Slim Sixty 1/4" Drive Socket Set

- Slim sixty ratchet 1/4": 60 teeth
 - Lever change
 - Push button release
 - Slim head
- Code: 4985T014SET41SS**



Carolus 51 Pce Slim Sixty 1/4" Drive Socket Set

- Slim sixty ratchet 1/4": 60 teeth
 - Lever change
 - Push button release
 - Slim head
- Code: 4985T014SET51SS**



Carolus 22 Pce Slim Sixty 3/8" Drive Socket Set

- Slim sixty ratchet 3/8": 60 teeth
 - Lever change
 - Push button release
 - Slim head
- Code: 4985T038SET22SS**



Carolus 26 Pce Slim Sixty 3/8" Drive Socket Set

- Slim sixty ratchet 3/8": 60 teeth
 - Lever change
 - Push button release
 - Slim head
- Code: 4985T038SET26SS**



Carolus 40 Pce Slim Sixty 3/8" Drive Socket Set

- Slim sixty ratchet 3/8": 60 teeth
 - Lever change
 - Push button release
 - Slim head
- Code: 4985T038SET40SS**



Carolus 14 Pce 1/2" Sq Drive Socket Set

- For deep-fitting screws, studs etc
 - 10 - 32mm sockets
 - Length 75mm
- Code: 4985T012SET14**



Carolus 24 Pce 1/2" Sq Drive Socket Set

- Contains 1/2" reversible ratchet with 2-component handle
 - For deep-fitting screws, studs etc
 - 10 - 32mm sockets
 - Length 75mm
- Code: 4985T012SET24**



Carolus 14 Pce 3/4" Sq Drive Socket Set

- Contains 3/4" ratchet
 - 22 - 50mm sockets
- Code: 4985T034SET14**



Carolus 32 Pce Slim Sixty 1/2" Drive Socket Set

- Slim sixty ratchet 1/2": 60 teeth
 - Lever change
 - Push button release
 - Slim head
- Code: 4985T012SET32SS**



SOCKET SETS



Carolus 77 Pce Slim Sixty 1/2" Drive Socket Set

- Slim sixty ratchet 1/2": 60 teeth
- Lever change
- Push button release
- Slim head

Code: 4985T012SET77SS



Hardman 24 Pce 1/2" Sq Drive Socket Set

- Supplied in metal case
- 20 sockets
- 1 quick release ratchet handle
- 1 universal joint
- 2 extension bars

Code: ATSOCKETSET



Unior 16 Pce 1/4" Drive Socket Set

- 4 - 13mm sockets

Code: 6003T611996



Unior 24 Pce 3/8" Drive Socket Set

- 6 - 22mm sockets

Code: 6003T612509



Unior 14 Pce 1/2" Drive Socket Set

- 10 - 24mm sockets

Code: 6003T611940



We also stock sets from the following leading brands:



Please check for details.

SOLDERING IRONS

Weller

Weller 12W Mini 2000 Series

12w - 15mm Tip - Code: **4777T12W**

15w - 20mm Tip - Code: **4777T15W**

20w - 35mm Tip - Code: **4777T20W**

Specially designed for the electronic hobbyist

Ergonomically designed handle

Lightweight iron perfectly balanced

Nickel plated, straight tip



Weller 15W Fine Duty Soldering Iron

- For fine duty work electronics, light duty electrical repairs and hobby work
- Fitted with 35mm straight tip, nickel plated
- MT6 Soldering Iron tip to suit

Code: **4774TSI15D**



Weller 25W General Duty Soldering Iron

- For general electrical repairs in the home and hobby workshop
- Fitted with 45mm bent tip, nickel plated
- MT9 Soldering Iron tip to suit

Code: **4774TSI25D**

Weller 40W General Duty Soldering Iron

- For general electrical repairs in the home and hobby workshop
- Fitted with 63mm bent tip, nickel plated
- S36/S37 Soldering Iron tip to suit

Code: **4774T40W**

Weller 75W Heavy Duty Soldering Iron

- For making metal repairs, such as battery connections and small metal joining tasks
- Fitted with 95mm bent tip, nickel plated
- S38/S39 Soldering Iron tip to suit

Code: **4774T75W**



Weller 170W Heavy Duty Soldering Iron

- For the professional user and light industrial operator
- Fitted with 160mm bent tip, nickel plated
- MT40 Soldering Iron tip to suit

Code: **4774T175W**

Weller 120W Heavy Duty Soldering Iron

- For the professional user and light industrial operator
- Fitted with 125mm bent tip, nickel plated

Code: **4774T120W**

Weller Pyropen (Gas)

- This soldering iron, operated using butane gas, has infinitely variable temperature control
- Easy to handle, requires on power cord or batteries and is electronically completely neutral
- Recharged in seconds

Code: **4779TWSTA1**



Weller Universal Soldering Gun

- Universal soldering gun ideal for hobbies, model making and home repairs
- Operated by fingertip trigger, ready to solder in 7 seconds
- Black housing with copper soldering tip

Code: **4781T9200UD**



Weller Tips For The Expert Soldering Gun 9200

- Copper Soldering Tip - Code: **4791T7135**
- Cutting Tip - Code: **4791T6110**
- Smoothing Tip - Code: **4791T6120**



Weller 100W Expert-Craft Gun Kit

- A versatile kit for soldering, powerwork, stained glass work, mending and sealing plastics, cutting polystyrene and jewellery work.

Kit contains

- 8100 Expert Soldering Gun
- Coil of multi-purpose solder, cutting tip, smoothing tip, soldering tip, soldering aid tool
- All contained within a sturdy compact carrying case

Code: **4781T8100UDK**



SPANNERS



Carolus Ring Spanner

- According to DIN 838, ISO 3318, ISO 1085, ISO 10104
- Rings offset
- Chrome-vanadium, chrome-plated



Code	Size
4983T0607	6 x 7mm
4983T0809	8 x 9mm
4983T1011	10 x 11mm
4983T1213	12 x 13mm
4983T1415	14 x 15mm
4983T1617	16 x 17mm
4983T1719	17 x 19mm
4983T1819	18 x 19mm
4983T2123	21 x 23mm
4983T2224	22 x 24mm
4983T2427	24 x 27mm
4983T3032	30 x 32mm

Unior Ring Spanner

- Material: chrome vanadium
- Surface finish: chrome plated according to EN 12540
- Polished head
- Made according to standard ISO 10104
- Drop forged, entirely hardened and tempered



Code	Size
6002T490007	6 x 7mm
6002T540009	8 x 9mm
6002T560011	10 x 11mm
6002T580013	12 x 13mm
6002T590017	13 x 17mm
6002T600015	14 x 15mm
6002T620017	16 x 17mm
6002T630019	18 x 19mm
6002T600526	20 x 22mm
6002T840022	19 x 22mm
6002T650024	22 x 24mm
6002T660026	24 x 26mm
6002T660027	24 x 27mm
6002T680030	27 x 30mm
6002T690032	30 x 32mm

Carolus Ring Spanner Set

- 8 Pce: 6 - 22mm
- 12 Pce: 6 - 32mm
- According to DIN 838, ISO 3318, ISO 1085, ISO 10104
- Rings offset
- Chrome-vanadium, chrome-plated

8 Pce Set - **Code: 4983TSET8**

12 Pce Set - **Code: 4983TSET12**



Hardman®
WORK TOUGH TOOLS

Ask sales for details.

Carolus Combination Spanner

- According to DIN 3113, Form A, ISO 7738
- Ring offset to 15°
- Chrome-vanadium, chrome-plated



Code	Size
4982T07	7mm
4982T08	8mm
4982T09	9mm
4982T10	10mm
4982T11	11mm
4982T12	12mm
4982T13	13mm
4982T14	14mm
4982T15	15mm
4982T16	16mm
4982T17	17mm
4982T18	18mm
4982T19	19mm
4982T20	20mm
4982T21	21mm
4982T22	22mm
4982T24	24mm
4982T27	27mm
4982T30	30mm
4982T32	32mm
4982T33	33mm
4982T34	34mm
4982T36	36mm
4982T38	38mm
4982T41	41mm
4982T46	46mm
4982T50	50mm
4982T55	55mm
4982T60	60mm

Unior Combination Spanner

- Material: chrome vanadium
- Surface finish: chrome plated according to EN 12540
- Polished head
- Drop forged, entirely hardened and tempered
- Made according to standard ISO 7738



Code	Size
6001T49	6mm
6001T52	7mm
6001T54	8mm
6001T55	9mm
6001T56	10mm
6001T57	11mm
6001T58	12mm
6001T59	13mm
6001T60	14mm
6001T61	15mm
6001T62	16mm
6001T83	17mm
6001T63	18mm
6001T84	19mm
6001T64	20mm
6001T645	21mm
6001T65	22mm
6001T655	23mm
6001T66	24mm
6001T67	25mm
6001T675	26mm
6001T68	27mm
6001T687	28mm
6001T69	30mm
6001T692	32mm
6001T71	36mm
6001T718	38mm
6001T725	41mm

SPANNERS



Carolus Combination Spanner Set

- 8 pce set - 10 - 19mm
 - 12 pce set - 10 - 32mm
 - According to DIN 3113, Form A, ISO 3318, ISO 7738
 - Ring offset to 15°
 - Chrome-vanadium, chrome-plated
- 8 Pce Set - **Code: 4982TSET8**
 12 Pce Set - **Code: 4982TSET12**



Unior Combination Spanner Set

- 8 pce set - 8 - 19mm
 - 17 pce set - 6 - 22mm
- 8 Pce Set - **Code: 6001T610837**
 17 Pce Set - **Code: 6001T600383**

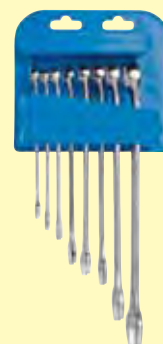

Carolus Reversible Ratchet Spanner

- Ring offset to 15°, reversible for right and left hand operation
- Chrome-vanadium steel
- Chrome-plated
- Jaw set at 15°
- Ratchet mechanism with 72 teeth
- Smallest return angle



Code	Size
4980T08	8mm
4980T09	9mm
4980T10	10mm
4980T11	11mm
4980T12	12mm
4980T13	13mm
4980T14	14mm
4980T15	15mm
4980T16	16mm
4980T17	17mm
4980T18	18mm
4980T19	19mm
4980T20	20mm
4980T21	21mm
4980T22	22mm
4980T24	24mm
4980T27	27mm
4980T30	30mm
4980T32	32mm
4980T171036	36mm

Unior Combination Ratchet Wrench

- Material: chrome vanadium
- Drop forged, entirely hardened and tempered
- 72 - teeth, 5° working angle



Code	Size
6001T611609	8mm
6001T611610	9mm
6001T611611	10mm
6001T611612	11mm
6001T611613	12mm
6001T611614	13mm
6001T611615	14mm
6001T611616	15mm
6001T611617	16mm
6001T611618	17mm
6001T611619	18mm
6001T611620	19mm
6001T617753	20mm
6001T617754	21mm
6001T617755	22mm
6001T617756	24mm

Carolus Open End Spanner

- Double open ended spanner
- According to DIN 3110, ISO 3318, ISO 1085, ISO 10102
- Chrome-vanadium, chrome-plated



Code	Size
4984T0607	6 x 7mm
4984T0809	8 x 9mm
4984T0810	8 x 10mm
4984T1011	10 x 11mm
4984T1013	10 x 13mm
4984T1213	12 x 13mm
4984T1317	13 x 17mm
4984T1415	14 x 15mm
4984T1617	16 x 17mm
4984T1719	17 x 19mm
4984T1819	18 x 19mm
4984T2022	20 x 22mm
4984T2123	21 x 23mm
4984T2224	22 x 24mm
4984T2427	24 x 27mm
4984T2730	27 x 30mm
4984T3032	30 x 32mm
4984T3236	32 x 36mm

Unior Open End Wrench

- Material: chrome vanadium
- Surface finish: chrome plated according to EN 12540
- Polished head
- Drop forged, entirely hardened and tempered
- Made according to standard ISO 10102



Code	Size
6000T600060	5.5 x 7mm
6000T600062	7 x 8mm
6000T600065	8 x 10mm
6000T600069	10 x 12mm
6000T600075	12 x 14mm
6000T600076	13 x 14mm
6000T600077	13 x 15mm
6000T600080	14 x 17mm
6000T600088	20 x 22mm
6000T600089	21 x 23mm
6000T600091	22 x 27mm
6000T600094	24 x 30mm
6000T600095	25 x 28mm
6000T600098	27 x 32mm
6000T600100	32 x 36mm
6000T600102	36 x 41mm

Carolus Open End Spanner Set

- Double open ended spanner
- According to DIN 3110, ISO 3318, ISO 1085, ISO 10102
- Chrome-vanadium, chrome-plated

8 Pce Set: 6 - 22mm - **Code: 4984TSET6**

12 Pce Set: 6 - 32mm - **Code: 4984TSET12**



Unior Open End Wrench Set

- 6 - 32mm sizes
 - Double open ended spanner
- 12 Pce Set - **Code: 6000T600106**



STAPLERS & STAPLES

Arrow Heavy Duty Staple Gun T50

Code: 4932TT50FP

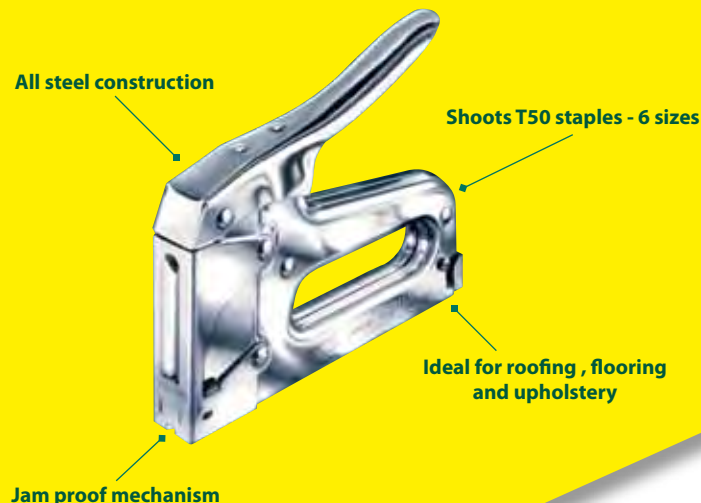

Arrow ET501

Electric Stapler/Nail Gun

- Heavy duty electric stapler/nail gun
- For insulation and upholstery applications
- Composite plastic body with cushion grip, slip resistant palm grip
- Fully adjustable power knob allows the fastening to be driven to greater depth

Code: 4932TET501



Arrow Professional Heavy Duty Staple & Nail Gun T50PBN

- Shoots staples up to 14mm
- Drives brad nails 15mm
- Uses T50 staples and BN18101P brad nails
- Ideal for picture framing, roofing, flooring and upholstery

Code: 4932TT50PBN

Arrow Staple Gun Tacker T55

- Baked enamel finish
- All steel construction
- Hand contoured handle
- Safety handle lock
- Visual refill window
- Patented jam proof mechanism
- Moulded plastic handle stop

Code: 4932TT55



Arrow Heavy Duty Hammer Tacker HT50

- All steel construction
- Use 3 types of T50 staples: 8mm, 10mm, 12mm
- Ideal for carpeting, insulating, upholstery
- Durable chrome finish
- Patented jam-proof mechanism

Code: 4932THT50A



Stanley Heavy Duty TR250 Staple Gun / Brad Nailer

- Pinch point free design
- Easy push handle
- Aluminium cast housing
- Easy access staple & brad insertion
- Lock down handle
- Accepts heavy duty staples and brads
- Internal wire guide
- Hi/Lo adjustment
- Can be used on plywood and MDF

Code: 2894T0TR250



Stanley Heavy Duty TR150HL Staple Gun

- Pinch point free design
- Easy push handle
- Aluminium cast housing
- Lock down handle
- Takes heavy duty staples
- Easy access staple insertion
- Hi/Lo adjustment
- Can be used on plywood and MDF
- Suitable for carpet fitters, carpenters, decorators and gardeners

Code: 2894T0TR150HL





STAPLERS & STAPLES

Arrow Staples T50

- 1/4" - Code: 4935T014
- 5/16" - Code: 4935T015
- 3/8" - Code: 4935T016
- 1/2" - Code: 4935T018
- 9/16" - Code: 4935T019



Arrow T50 Ceiltile Staples

- 13mm - Code: 4935TCT



Arrow Staples T25

- 3/8" - Code: 4941T016
- 7/16" - Code: 4941T017
- 9/16" - Code: 4941T019



Arrow Stainless Staples T50

- 6mm - Code: 4935T014SS
- 8mm - Code: 4935T015SS
- 10mm - Code: 4935T014SS

Arrow Brad Nails

- 15mm - Code: 4935T0015
- 22mm - Code: 4935TB1812B



Arrow Staples JT21 + T27

- 1/4" - Code: 4934T014
- 5/16" - Code: 4934T015
- 3/8" - Code: 4934T016



Arrow Staples P35

- 1/4" - Code: 4940T014
- 3/8" - Code: 4940T016



Stanley

Light Duty Staple Packs

- Only suitable for light duty staplers
- TR45 take all sizes and 0 - TR40 takes 6, 8 and 10mm

- 6mm - Code: 2894TTRA204T
- 8mm - Code: 2894TTRA205T
- 10mm - Code: 2894TTRA206T



Stanley

Heavy Duty Staple Packs

- Only suitable for heavy duty staplers and hammer tackers
- Staples take all sizes and hammer tackers take 8, 10 and 12mm

- 6mm - Code: 2894TTRA704T
- 8mm - Code: 2894TTRA705T
- 10mm - Code: 2894TTRA706T
- 12mm - Code: 2894TTRA708T
- 14mm - Code: 2894TTRA709T



Arrow Staples P22

- 1/4" - Code: 4938T014
- 5/16" - Code: 4938T015



Arrow Wire and Cable Stapler / Tacker T25

- Durable chrome finish
- All-steel construction
- Cushioned grip
- Grooved guide
- Grooved driving blade
- Patented jam-proof mechanism
- Easy squeeze double-leverage operation

Code: 4941T25M



Arrow Light Duty / Household Staplers T27

- Durable hi-impact moulded plastic housing
- Safety handle lock
- All steel channel track
- Visual refill window
- Patented jam-proof mechanism
- Built in staple lifter
- T27

Code: 4933TT27



Stanley Light Duty Staple Gun

- Easy push handle
- Staple re-load window
- Easy access staple insertion
- Built in staple remover
- Takes 6, 8 and 10mm light duty staples

Code: 2894T0TR40



Arrow Plier Type Stapler P35

- Durable chrome finish
- All steel construction
- Hand guard loop
- Cam actuated double leverage
- 63.5mm throat depth
- Easy to get at mechanism

Code: 4938TP22
Heavy Duty - Code: 4940TP35



STORAGE

Stanley 26" Galvanised Toolbox

Code: 2891T192211



STANLEY

Stanley Tool Apron

- 600 denier fabric
- Padded back for extra comfort
- Integrated metal hammer loop
- Tape pocket
- Multiple pockets and loops for maximum organisation

Code: 2891T196178



Stanley Fatmax Xtreme Tool Vest

- Multiple storage pockets for easy organisation
- Detachable Tool Pouch
- Air mesh material
- Fully adjustable for use with other clothing on all seasons

Code: 2891T195629



Stanley Professional Mobile Toolchest With Soft Pocket

- Easy transportation and storage for larger tools
- Extra large nickel plated metal latches
- Transparent polycarbonate organiser in lid impact resistant
- Soft side pocket organiser
- Removable tote tray
- Removable cups for small accessories storage
- Multi purpose V groove on top lid for working with pipes and timber
- Wide telescopic steel handle with soft grip
- Heavy duty road tested wheels

Code: 2891T192083



Stanley Fatmax Pro Professional Mobile Job Chest

- Huge volume allows storage of the biggest items
- All round water seal for all weather use (rated IP54)
- Structural foam for longer life
- Large metal rust proof latches for long life
- Vertical storage and portable tray included
- Integrated V-groove for cutting
- Integrated lock for ultimate protection
- Secure storage for saw and level within lid
- Heavy duty road tested wheels

Code: 2891T194850



Stanley Fatmax Xtreme Security Toolchest

- Integrated keypad security system and key lock
- 42 gallon capacity
- 4mm thick walls for increased rigidity and strength
- Water seal rated at IP54 for protection against dust and water
- Gas strut for easy opening and closing
- Heavy duty 8 1/2" wheels
- Removable vertical storage
- Removable tote tray
- Telescopic handle for easy manoeuvring

Code: 2891T197488



Stanley Fatmax Cantilever Rolling Workshop

- Toolbox with lift out tray
- Large adjustable organiser
- Heavy duty road tested wheels
- Ball bearing slides for smooth opening even with heavy loads
- Opens up easily into a 4 level workstation
- Giant lower bin
- Telescopic handle for easy manoeuvrability
- Metal latches for long life
- Can hold up to 40kg

Code: 2500T194210



Stanley Fatmax Metal Plastic Rolling Workshop

- Complete mobile solution for large and small tools and accessories
- Toolbox with lift out tray
- Metal latches for long life
- 2 drawer mid section
- Extendable handle for easy manoeuvrability
- Huge storage bin base
- Heavy duty road tested wheels

Code: 2891T195622



Hardman 24" Hard Base Toolbag

- 24" wide top opening ideal for storing and carrying a wide range of tools and accessories
- Made from durable heavy duty polyester with side pockets and reinforced handles
- Metal frame provides extra strength and stability
- C/W adjustable shoulder strap

Code: AT87001



Stanley Fatmax 18" Open Tote Tool Bag

- Heavy duty 600 denier fabric with leather reinforcements
- Rigid and waterproof plastic base
- Heavy duty steel handlebar
- Shoulder strap allows easier carrying
- Velcro straps ideal for securing a 600mm level
- Multiple use tool compartments for all storage needs

Code: 2500T193951



Stanley Sortmaster Organiser

- Unique 90° compartments allow easy storage
- Customisation with removable dividers for all items
- Lid structure prevents movement of small parts from one compartment to another
- Lid lock to hold items securely
- 1024 different compartments for ultimate flexibility

Code: 2500T194745



Stanley Fatmax Deep Pro Organiser

- Waterproof Seal protects the contents from rust
- 12 removable compartments that can be stacked
- Polypropylene lid that is virtually unbreakable
- Metal latches provide additional strength and improve loading capabilities
- Side latches allow multiple organisers to be clipped together
- Multiple latches ensure contents securely stored
- Unique lid design locks all compartments in place

Code: 2891T197518



STORAGE

STANLEY

Stanley 18" Wheeled Soft Bag

- Heavy duty 600 denier fabric that resists cuts and scratches
- Multiple internal & external pockets for maximum organisation
- Extendable handle to easily manoeuvre the bag
- Removable divider
- Easy access to tools
- Secure storage of small parts or personal items



Code: 2891T197515

Stanley Fatmax Xtreme Open Tote Tray

- 3 ply construction
- The most heavy duty 1200 denier fabric for long lasting durability
- Rigid and waterproof plastic base
- Stainless steel bar handle
- Padded Shoulder Strap allows easier carrying
- Velcro straps ideal for securing a 600mm level
- Saw Compartment with strap
- Multiple use tool compartments
- Semi rigid construction maintains shape and allows easy access



Code: 2500T193957

Stanley Fatmax Xtreme Round Top Tool Bag

- 3 ply fabric construction
- The most heavy duty 1200 denier fabric
- Rigid and waterproof plastic base
- Padded Shoulder Strap
- Multiple use tool compartments
- Magnetic quick close operation of the "2 position" pockets
- Round top geometric construction
- Semi rigid construction



Code: 2500T193955

Stanley Fatmax Waterproof Toolbox

- Waterproof storage solution
- All round water seal
- Structural foam construction
- Extra-large storage capacity
- Portable tote tray
- Integrated V-groove on top lid
- Tough Soft grip handle
- Metal latches with padlock eyes



28" Toolbox Code: 2500T193935

Stanley Professional Rainproof Toolbox

- Splash proof design prevents rain water entering the toolbox
- 2 padlock eyes to keep tools safe
- Soft rubber bumper corners provide impact protection
- Full length "easy-grab" aluminium handle
- 24"/60cm level holder in lid keeps level secure (26" version only)

20" Toolbox Code: 2891T192251
26" Toolbox Code: 2891T192258



Stanley Fatmax Metal Toolbox

- Large metal latches with padlock eye for rust protection and long life
- TPR Coated Handle more ergonomic and comfortable grip
- 1 long metal hinge reduces possibility of hinge failure
- Design allows vertical storage

20" Toolbox Code: 2891T195615
23" Toolbox Code: 2891T195616
26" Toolbox Code: 2891T195617



Stanley Metal Latched Toolbox

- Metal latches for extra weight capacity and longer life than plastic latches
- Metal hinge from lid to body for extra weight
- 2 top lid organisers for storing small parts
- Soft grip handle

12" Toolbox Code: 2891T192064
16" Toolbox Code: 2891T192065



Stanley Toolbox With Level Compartment

- Metal latches for extra weight capacity and longer life than plastic latches
- Metal hinge from lid to body for extra weight
- 2 top lid organisers for storing small parts
- Soft grip handle

26" Toolbox Code: 2891T192850





STORAGE

Talco Cantilever Toolbox

- Safety edges
- Padlock facility
- Full length piano hinges

17" Toolbox - 3 Tray - **Code: 7043T1700**
 17" Toolbox - 5 Tray - **Code: 7044T1700**
 22" Toolbox - 3 Tray - **Code: 7043T2200**
 22" Toolbox - 5 Tray - **Code: 7044T2200**

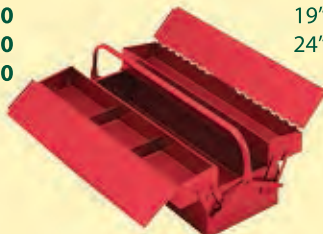

Talco Barn Toolbox

- C/W removable tote tray
- Constructed with turned safety edges
- Padlock facility and full length piano hinges

14" Toolbox **Code: 7042T1400**
 19" Toolbox **Code: 7042T1900R**
 24" Toolbox **Code: 7042T2400**



Talco Compact Combination Chest

- This practical chest stacks with any of the compact range roller cabinets
- It has a deep top till and full width drawers all of the same size
- Lid fitted with toggle fastener which can be padlocked

550x290x392mm - 4 drawer
Code: 7064TCOM4DTC
 550x290x392mm - 6 drawer
Code: 7064TCOM6DTC



Carolus 9 Drawer Top Box

- Two carry handles to help when lifting the top box
- This Carolus top box is lockable and comes with 2 keys
- 9 ball bearing sliding drawers
- Comes with a metal tote tray
- Dimensions of this top box are 660 x 307 x 435mm

Code: 4994T20721300



Carolus Tool Trolley With 7 Drawers

- Industrial quality
- 25kg load capacity per drawer
- Easy glide drawers on roller bearings
- Fully lockable with cylinder lock
- Heavy duty castors, 2 fixed, 2 swivel with foot brake

Code: 4994T20701300



Hardman Sack Truck

- P-Handle for comfort and easier control
- 1" heavy duty bar construction
- Heavy duty 4-ply treaded pneumatic tyres
- Extra large toe plate for greater load stability
- 700lb capacity

Truck - **Code: AT05001**
 Spare Wheel - **Code: AT05004**



Hardman 3 in 1 Sack Truck

- 1" heavy duty tubular steel construction
- Extra support at 45° for heavy load handling
- 400mm x 300mm loading plate dimensions
- Includes rear castor wheels for ease of movement and extra support
- Pneumatic tyres

Truck - **Code: AT06001**
 Spare Wheel - **Code: AT06002**



STORAGE



Plano Drill Holster

- Cordless holster
- Reinforced material
- For cordless power tools up to 18V
- Pockets for bits and accessories
- Strap secures drill

Code: 4666T531T



Plano Tape Holder

- Reinforced material
- Fits most 5mtr tape measures
- Pen holder
- Front pocket for notepad

Code: 4666T532T



Plano Electrician's Tool Pouch

- Reinforced material
- Insulation tape holder
- Loop for large tools
- 1 large and 2 medium pockets
- Zipped pocket for documents
- 4 terminal screwdriver/pen pouches

Code: 4666TPL535T



Plano Mobile Phone Pouch

- Padded material
- Pen holder
- Metal clip fits all belts

Code: 4666TPL539T



Plano 23 Pocket Toolbelt

- 23 pocket toolbelt for tools and small items, nails, screws etc.
- Hammer loop & tape holder
- Quick-release buckle
- c/w hammer loop

Code: 4666TPL52170



Plano 15 Pocket Toolbelt

- 15 pocket toolbelt for tools and small items, nails, screws etc.
- Cordless drill holster, hammer loop & tape holder
- Quick release buckle
- c/w drill holster

Code: 4666TPL52180



Plano Carpenters Belt

- Hard wearing material
- Metal hammer and tape holders
- Large front pocket for nails and screws
- Quick release metal buckle
- c/w hammer loop

Code: 4666TPL546T



Plano Tool Bumbag

- Reinforced material
- Carry handle
- Document compartment inside flap
- Zipped pocket to front
- Adjustable waist belt

Code: 4666TPL545T



Plano 13" Hardbottom Toolbag

- Strong - welded plastic base
- 17 pockets
- Ideal for carrying test equipment

Code: 4666TPL513000



Plano 17" Hardbottom Toolbag

- Strong - welded plastic base
- 11 pockets
- One side pocket zipped for safe storage

Code: 4666TPL513001



Plano Reflective Rucksack

- Padded & reinforced back for bulky tools
- Adjustable shoulder strap
- Base holds one Planobox 3600 (not inc.)
- Ideal for tradesmen cycling to site or using public transport

Code: 4666TPL542T



Plano Workstation Toolcase For Precision

- Professional bag/workstation
- Reinforced material
- Ideal for electronic tools
- Opening on both sides
- Large outer pocket for documents

Code: 4666TPL552T



Hardman Black Leather Multi Tool Pouch

- Complete with tape holder, stainless hammer swinger, plier holder and leather belt
- Reinforced at stress points
- Double stitched for extra strength

Code: AT52003A



Hardman Black Leather Multi Tool Pouch Single

- Complete with stainless hammer swinger, plier holder and leather belt
- Reinforced at stress points
- Double stitched for extra strength

Code: AT52037



Hardman Canvas Multi Tool Pouch

- Complete with tape holder, hammer swinger, plier holder and web belt
- Reinforced at stress points

Code: AT52015A



Hardman Canvas Multi Tool Pouch Single

- Complete with hammer swinger, plier holder and web belt
- Reinforced at stress points

Code: AT52036



BOSCH
Invented for life

All Bosch Power Tools
& Accessories available.
Please check for details.

TILING

Vitrex 250W Multi Tool

- Quick and easy attachment change system
- Can be used at various angles making it perfect for any project
- Suitable for the professional tradesman & DIY enthusiast
- Supplied with robust storage case

Code: 4601TMULTITOO

Supplied With

- Grout removal tool
- Paint & wallpaper scraper
- Sanding pads x 3
- Plunge cut & undercut saw blade
- Dust extraction attachment

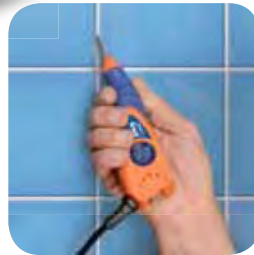

Vitrex 

Vitrex 750W Wet Tile Saw

- Fully adjustable mitre guide
- Table tilts
- Diamond blade
- Powerful
- Robust
- Cuts wall and floor tiles up to 25mm thick

Code: 4601T103420

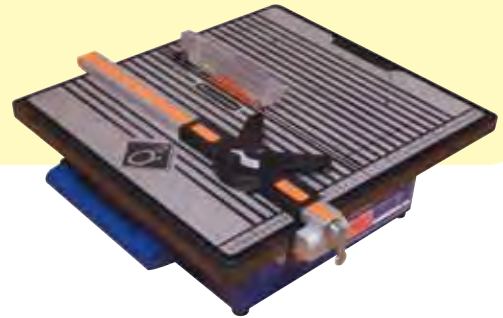

Vitrex Grout Out

- Electric grout remover
- Variable speed for precision grout removal
- The easiest way to refresh any tiled area
- Interchangeable grout removing tips
- 2.5m power cable allows a greater working area

Code: 4601TGROUTOUT

Vitrex Flat Bed Tile Cutter

- Easy to use cutting action
- Tungsten carbide cutting wheel 14mm with variable height adjustment
- Sturdy polypropylene base with steel reinforcement and integral ruler
- Suitable for cutting wall, floor and quarry tiles up to 300mm square and 12mm thick

Code: 4601T102400



Vitrex Heavy Duty Tile Cutter

- Professional heavy duty flat bed tile cutter, with a rigid steel construction and integral angle cutting guide
- Easy to use with a simple score and snap cutting operation
- Cuts ceramic wall and floor tiles up to 330mm square and 16mm thick
- Diagonal cuts also possible on tiles up to 250mm square tiles quickly

Code: 4601T101490



Hardman Top Diamond Tile Drill

- A topline of welded tip diamond drills with a reverse spiral design to feed water to the cutting face, plus in-built core ejection system to prevent clogging
- Suitable with most power drills
- Suitable for use with porcelain, granite, quarry, stone, marble, terracotta and ceramic

Code	Size
AT71000	5 x 30mm
AT71001	6 x 30mm
AT71002	7 x 30mm
AT71003	8 x 30mm

Code	Size
AT71004	10 x 30mm
AT71005	12 x 30mm
AT10006	16 x 30mm
AT71007	20 x 30mm
AT71008	25 x 30mm
AT71009	30 x 30mm
AT71010	35 x 30mm
AT71011	Water Feed & Drill Guide Unit

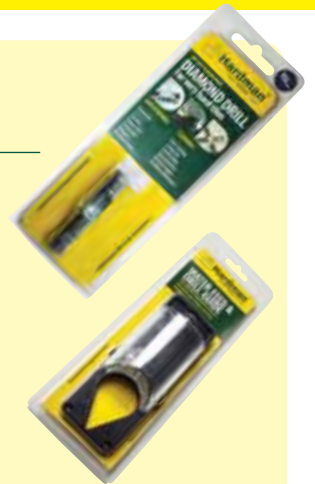

Vitrex Hard Tile Bits

- Diamond grit edged bit, ideal for drilling hard tiles
- Slotted bit design for easy waste removal
- Suitable with most power drills
- Suitable for use with porcelain, granite, quarry, stone, marble, terracotta and ceramic



Code	Size
4601T102791	6mm
4601T102792	8mm
4601T102793	10mm
4601T102794	12mm
4601T102795	15mm
4601T102796	18mm
4601T102797	22mm
4601T102798	25mm

Vitrex Tungsten Carbide Tile Bits

- Precision spear-head design prevents chipping or breaking

6mm - Code: **4601T49**
10mm - Code: **4601T56**



Vitrex Tile Scorer

- Tungsten Carbide Tip
- Suitable for scoring floor and wall tiles

Code: **4601T102075**



Vitrex Tile Nippers

- Tungsten Carbide tipped jaws for cutting and shaping wall tiles
- Ideal for awkward shaped cuts around pipes, switches, sills and fittings
- Soft feel handles

Code: **4601T102430**



Vitrex Tile Saw

- Soft grip handle for extra comfort
- Extra deep steel frame for improved cutting access
- Cutting depth of 150mm i.e. to the centre of a 300mm tile
- 150mm Tungsten Carbide Blade - cuts in any direction

Code: **4601T102207**

Vitrex Blade

- 150mm Tungsten Carbide Rod Saw Blade

Code: **4601T102203**

TILING



Suretile Multispacer 1/4"

- For walls and floors
- Highlights raised tile edges for correction
- Innovative depth gauge for even tiling
- Levelling guide
- Unique adhesive remover
- Finishes grout smoothly
- Properly aligns corners
- Spaces tiles evenly
- Always to hand

Code: SURMULTI

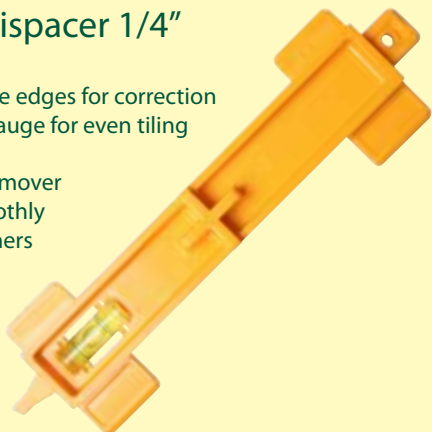

Suretile Tile Lifter 1/4"

- The Tile Lifter enables you to get behind the tile needing adjustment without affecting adjacent tiles
- Insert the Tile Lifter down the grout line and then turn it behind the tile
- Gently pull the tile outwards to the correct depth

Code: SURLIFTER

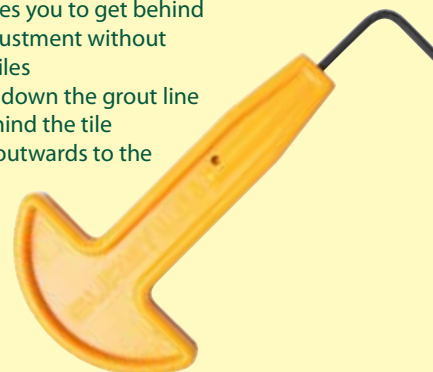

Suretile 20 x Tile Spacers

- Re-usable
- Easy to handle and use
- Maintains grout line round corners
- Doesn't stay buried in the wall/floor
- No wasted spacers, no wasted money
- Made from tough recyclable ABS
- Made in the UK

2mm - **Code: SURUNIPLUG**

4mm - **Code: SURUNIPLUG4MM**

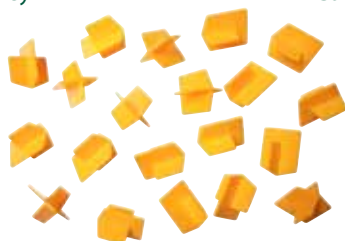

Vitrex Grout Rake

- Tungsten Carbide grit edged blade for longer life
- Durable nylon handle designed for extra grip
- For removing old and discoloured grout

Code: 4601T102420



Vitrex Tile Spacers

- The easy way to achieve a more professional finish
- Ensures an even grout line throughout



Code	Size	Qty Per Box
4601T102151	1.5mm	250
4601T102152	1.5mm	500
4601T102000	2mm	500
4601T102251	2.5mm	250
4601T102252	2.5mm	500
4601T102023	2.5mm	1000
4601T102041	4mm	250
4601T102010	4mm	350
4601T102050	5mm	100
4601T102051	5mm	250

Vitrex Tile Spreader

- Conventional dual purpose design
- Notched edge for fast adhesive application
- Squeegee edge for rapid grouting

Code: 4601T102277



Vitrex Tiling Sponge

- Heavy duty sponge for removing excess grout

Code: 4601T102904



Vitrex Large Spreader

- Strong flexible plastic spreader with notched edge for fast adhesive application
- Contoured handle for extra comfort

Code: 4601T102961



Vitrex

Flextip Sealant Smoother

- Moulded plastic handle with flexible insert
- Provides a professional finish to most household sealant application
- Ideal for baths, basins, sinks etc.

Code: 4601T102283



Vitrex Large Squeegee

- 190mm
- Strong, flexible plastic blade with squeegee edge for rapid grouting
- Contoured handle for comfort

Code: 4601T102962



Vitrex Profile Gauge

- Quick and easy way to copy awkward shapes

150mm - **Code: 4601T101030**
 200mm - **Code: 4601T101033**
 300mm - **Code: 4601T102461**



Vitrex

Heavy Duty Tile Cutter

- Scoring and snapping ceramic tiles up to 10mm thick

Code: 4601T101490



Vitrex Adhesive Trowel

- Square Notch
- Stainless Steel Blade

Code: 4601T102909



Hardman Notched Trowel

- Innovative comfort grip handle
- 11" x 4 1/2"

Code: AT10010



Marshalltown

Fine Grout Float

- With white rubber outer layer to prevent marking
- Shaped leading corner to aid grout waste removal
- 9" x 4"

Code: 7114T43



Hardman Grouting Float

- Light
- Strong
- One-piece polyurethane construction
- 4" x 9"

Code: AT10040



Hardman Grouting Float

- Light
- Strong
- One-piece polyurethane construction

28 x 11cm - **Code: AT10046**
 35 x 15cm - **Code: AT10047**



TORCHES & LANTERNS



Stanley 3 In 1 Tripod Torch

Code: 2500T595155



Brennenstuhl Headlight

- 3 settings
- 10 Super-bright LED's
- 3 x standard AAA batteries (included)
- Wide flexible straps adjustable for any size of head

Code: 7201T1179770



Hardman 7 LED Head Lamp

- Ultra bright LED light
- High intensity LED
- Extensive lifetime of LED (100,000hrs)
- Adjustable headstrap
- Adjustable inclination
- Water resistant
- Requires 3 x AAA batteries (not included)

Code: AT45007

Unilite Prosafe 80 Lumen LED Headlight

- Uses 1 x AA battery (included)
- Rubber head and non-slip head straps
- 3M strips
- Emergency flash function
- Collimator lens
- Cree LED

Code: 8050TPSH2



Unilite Prosafe 120 Lumen LED Headlight

- Uses 2 x AA batteries (included)
- Non-slip head straps
- Focus control
- 3M strips
- LED dimming control
- Red SOS flash
- Red - Green LED
- SOS white LED function
- Cree LED

Code: 8050TPSH3



Unilite Prosafe 180 Lumen LED Headlight

- Infrared detection - sensor
- Uses 3 x AA batteries (included)
- 3M strips
- Focus control
- Emergency rear light - Red
- White LED SOS function
- LED dimming control
- Cree LED

Code: 8050TPSH5



Brennenstuhl Torch c/w Laser Pointer

- 8 Super-bright LED's
- Metal housing
- Integrated Laser Point
- 3 x AAA batteries included
- Soft-touch switch, 2 functions:
 - LED's on
 - Laser Pointer on

Code: 7021T1179890



Brennenstuhl 3 Piece Highlight LED Set

- 3 Powerful torches with 1,5 or 9 super-bright LED's
- Twist switch in head of torch
- Rubberised handle
- Waterproof
- 1 x AA, 3 x AAA
- 3 x AA Batteries included

Code: 7021T1178460

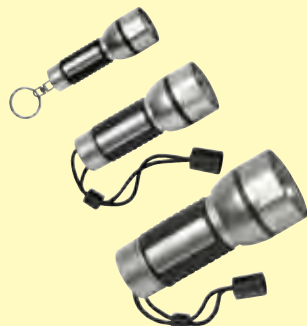

Brennenstuhl LuxPrimera LED 120

- High performance 3 Watt LED
- 2 settings and flash function
- Robust aluminium housing
- Dust & splashproof IP67
- 3 x AA Batteries included

Code: 7021T1178710



Brennenstuhl LuxPrimera LED 100

- High performance 1 Watt LED
- Compact design
- Robust aluminium housing
- Dust & splashproof IP65
- 1 x AA Battery (included)

Code: 7021T1178700



Brennenstuhl Torch & Keyring Light

- Compact torch with 3 super-bright LED's
- Twist switch in head of torch
- Rubberised handle
- Sturdy, stylish design
- Includes a bright LED light on a keychain
- Long lasting battery life
- 3 x AAA and 3 x AG3
- Batteries (included)

Code: 7021T1178440



Stanley Maxlife 369 LED Tripod Torch

- Unique tripod design for hands free convenience
- Can work off 3,6 or 9 batteries
- Uses AA batteries (not included)
- With 9 batteries - 1 LED can provide light for more than 8 days
- Weight 350g

Code: 2500T095112



Stanley Fatmax Aluminium Torch

- Specially designed reflector for a strong focused beam
- Heavy duty anodized aluminium for strength and durability
- Textured handle for firm grip
- Hi-viz yellow band can be easily seen in the toolbox
- Pocket size for convenience
- Weather resistant for outdoor use
- Shatter proof lens withstands drops and blows
- End push button easy to use
- Batteries (not included)

AA Batteries - **Code: 2500T195151**
 AAA batteries - **Code: 2500T195152**



Stanley Fatmax 3D Aluminium Torch

- Large robust body for heavy duty use
- Specially designed reflector for a strong focused beam
- Heavy duty anodized aluminium for strength and durability
- Textured handle for firm grip
- Hi-viz yellow band can be easily seen in the toolbox
- Weather resistant for outdoor use
- Shatter proof lens withstands drops and blows
- Front push button easy to use
- Uses D batteries (not included)

Code: 2500T195153



Stanley Heavy Duty Clamping Floodlight

- Patented clamping feature secures light to ceiling beams, floor joists, table tops for hands free working
- Rotational head direct light where needed
- High floodlighting capability to illuminate a large work area
- Ideal for any on site or DIY application requiring hands free use

Code: 2500T195891



TORCHES & LANTERNS

UNILITE
PROSAFE

brennenstuhl®

Unilite Prosafe

High Visibility Floating Lantern

- Uses 6v - PJ996 lantern battery
- Industrial strength co-polymer
- Carry strap included
- Beamaster lens

Code: 8050TPSL1



Unilite Prosafe 100 Lumen LED Flashlight

- Hi visibility
- Waterproof to 30 metres
- Magnetic switch
- 4 x AA batteries (included)
- Rubberised head for durability
- Carry strap
- Cree LED
- Magnetic switch

Code: 8050TPST1



Unilite Prosafe 'Plug-In' Rechargeable Lantern Battery

- Universal/Direct fit for any lantern/torch using a PJ996
- No separate mains charger required
- Plugs directly into any domestic mains socket
- Red LED indicates the product is charging
- Can be charged up to 750 times
- Short Circuit protected to prevent over charging
- High money savings in comparison to disposable batteries
- Better for the environment
- Size: 110mm x 80mm
- Weight: 415g

Code: 8050TPSRB1



Unilite Rechargeable Lantern System

- Exceptional lightweight
- Weighs less than 525g
- High impact professional weather-proof co-polymer lantern

Code: 8050TUK240



Unilite Prosafe Xenon Lantern

- Made from industrial grade synthetic rubber
- Weatherproof for all outdoor situations
- Effortless single-handed micro switch operation
- High intensity 4.8v Xenon bulb

Code: 8050TUK100



Brennenstuhl Rechargeable Hand Lamp

- 28 extra-bright LED's
- Equivalent to approx.. 40w incandescent bulb
- Approx 4-5 hours constant use when fully charged
- Ni-MH battery + charging unit
- 360° hanging hook and magnet facility
- Rubber-clad housing
- On/Off Switch
- Blister Pack

Code: 7201T1175343



Brennenstuhl Halogen Light

- The ideal light for buildings, entrances, gardens, sites, workshops etc
- Range of detection: up to 12 metres, angle 180°
- The duty cycle is adjustable between 15 sec and 5min
- With ON/OFF switch for continuous light and standard sensor operation
- Housing and frame made of aluminium pressure casting with coated surface
- Halogen bulb included

White - Code: 7201T1172190
Black - Code: 7201T1172360



Brennenstuhl Fluorescent

- With PL energy-saving bulb
- With switch
- Ergonomically designed hexagonal handle prevents rolling away
- 5m special oil-resistant rubber neoprene cable
- Bulb replacement
- Water jet protected IP44
- Blister

240v - Code: 7201T1177183
110v - Code: 7201T1177183110



Brennenstuhl Bulk Head Light

- Suitable for mounting on either walls or ceilings
- Cover: Crystal clear glass with inner prismatic structure
- Delivery without bulbs
- 60w coloured

Code: 7201T1270400



Brennenstuhl Jet Light Low Energy 36w

- Perfect for tradesman and advanced DIY workers
- Can be used in three positions- standing, suspended or lying flat
- Compact for carrying purposes
- Robust, shockproof housing with protective enclosure made of polycarbonate
- Stable, adjustable base
- Rubberised cable with B-S plug
- Lamps included
- Very bright light equivalent to a 200w bulb

Code: 7201T1172563



Hardman LED Site Lights

- Suitable for indoor or outdoor use
- Supplied with 3 metres of cable and approved plug
- Adjust able tripod constructed from tough tubular steel (extends from 105cm-195cm)



Code

Size

AT42910	240v Twin Head Site Light
AT42911	110v Twin Head Site Light
AT42912	240v Single Head Site Light
AT42913	110v Single Head Site Light

Hardman Inspection Lamps

- Rubberised grip
- Complete with 5 metre of cable

60w/240v - **Code: AT45001**

60w/110v - **Code: AT45002**



Hardman Gripper Inspection Lamp

- Economy hand lamp with self grip feature
- Complete with 5 metres of cable

240v/60w - **Code: AT45005**

110v/60w - **Code: AT45006**



Hardman Plasterers Light

- Fluorescent floor standing tripod light
- 110v twin socket can be linked in series
- Suspension hook for versatility
- IP 65 rated
- 24"

110v - **Code: AT43054**

240v - **Code: AT43055**



Hardman LED Portable Lights

- Comfortable padded carrying handle
- Toughened glass
- 45 LED's 180 Lumens

240v - **Code: AT42914**

110v - **Code: AT42915**



WOOD CHISELS

IRWIN
Marples.

Hardman
WORK TOUGH TOOLS

Irwin Marples Wood Chisels M373 Series

Code	Size
3614T009	1/8"
3614T014	1/4"
3614T016	3/8"
3614T018	1/2"
3614T020	5/8"
3614T022	3/4"
3614T100	1"
3614T114	1 1/4"
3614T118	1 1/2"
3614T200	2"



Irwin Marples M373 Splitproof Chisel Set

- Set of 6 splitproof Marples Bevel Edge Chisels
- Chisel sizes 1/4", 3/8", 1/2", 3/4", 1" and 1 1/4"
- Hardened blade & tempered
- Solid one piece forging with guaranteed unbreakable handles
- Supplied in high quality wooden storage case

Code: 3614TS6



Irwin Marples MS500 Bevel Edge Chisels with Striking Cap

- Blade hardened up to the last 25mm for a long working life
- Solid one-piece forged blade ensures structural integrity
- Blade lacquered for rust protection
- Large, strong tang keeps the handle firmly attached
- Impact-resistant polypropylene core handle
- Soft-touch friction grip for improved comfort
- Striking cap for use with hammers

Code	Size	Code	Size
3614TMS50014	1/4"	3614TMS50034	3/4"
3614TMS50038	3/8"	3614TMS50001	1"
3614TMS50012	1/2"	3614TMS500112	1 1/2"
3614TMS50058	5/8"	3614TMS50002	2"

Hardman Wood Chisels

- High impact bevel edge wood chisels
- Soft grip handle for improved comfort
- Metal striking cap allows use with suitable hammer
- Heat treated one piece forged blade gives greater strength and life
- High quality carbon steel gives longer lasting sharper edge

- 6mm - **Code: AT27001**
- 10mm - **Code: AT27003**
- 13mm - **Code: AT27004**
- 16mm - **Code: AT27006**
- 19mm - **Code: AT27009**
- 32mm - **Code: AT270010**
- 38mm - **Code: AT270011**



Hardman Wood Chisel Set

- 8 piece set
- Bevel edge chisel set & box
- c/w sharpening stone & honing guide

Code: AT27020



Stanley Fatmax Thru Tang Chisel

- Superior design 50% stronger handle for extra reassurance and durability
- Steel strikecap can be used with a steel hammer for increased cutting force
- Quality chrome alloy (ball bearing grade) steel provides superior edge retention
- Ergonomic soft grip handle for maximum grip and control
- Full length blade guard for added safety



Code	Size	Code	Size
2607T516251	6mm	2607T516261	25mm
2607T516252	8mm	2607T516262	30mm
2607T516253	10mm	2607T516263	32mm
2607T516254	12mm	2607T516264	35mm
2607T516255	14mm	2607T516265	38mm
2607T516256	15mm	2607T516266	40mm
2607T516257	16mm	2607T516267	50mm
2607T516258	18mm		
2607T516259	20mm	2607T516268	3 Pce Set
2607T516260	22mm	2607T516269	5 Pce Set



Bahco Wrecking Chisel

- Heavy duty product made from impact resistant PPE with a blade hardened, long lasting edge
- Curved knuckle protector can be used as a lever for hard work
- The back edge of the tool can be struck with a hammer to make working faster
- 4mm thick blade for heavy duty
- 100mm long blade which increases the striking area

Wrecking Chisel - **Code: 6160T2448**

Curved Blade Wrecking Chisel - **Code: 6160TSB2449**



For our range of 'G' Clamps
go to page 14



Please check for details.

WRENCHES

Bahco Capacity Adjustable Wrench

- 8069 - 4"/13mm - Code: 6163T0400
- 8070 - 6"/20mm - Code: 6163T0600
- 8071 - 8"/27mm - Code: 6163T0800
- 8072 - 10"/30mm - Code: 6163T1000
- 8073 - 12"/34mm - Code: 6163T1200
- 86 - 24"/63mm - Code: 6163T2400
- 87 - 30"/85mm - Code: 6163T3000

Phosphate finish



Precision hardened and anti-corrosion treated



Bahco Adjustable Wrench 90 Series

- Phosphate finish
- Precision hardened and anti-corrosion treated
- Comfortable thermoplastic handle and larger grip width
- 9071P 7 9072P may be used as a pipe wrench



Hardman Adjustable Wrench

- Comfort grip (6" - 12" only)
- Manufactured from chrome vanadium steel
- Black phosphate finish
- Smooth action with laser marked graduations



Bahco Capacity Adjustable Wrench

- 40% wider opening compared to standard adjustable wrenches
- Head combines slimness for accessibility with strength for performance
- Precision-hardened and anti-corrosion treated
- Comfortable slip free thermoplastic handle



- 6 1/2"/32mm - Code: 6160T9029
- 8"/38mm - Code: 6160T9031

Stanley Fatmax Ratcheting Adjustable Wrench

- Ratchet jaw eliminates the need to break the fastener
- Forged chrome vanadium steel construction for strength and durability
- Wide handle for comfort under high torque loads

- 6"/150mm - Code: 2998T097544
- 8"/200mm - Code: 2998T097545
- 10"/250mm - Code: 2998T097546
- 12"/300mm - Code: 2998T097547

Code	Size
6235T0600	6"
6235T0800	8"
6235T1000	10"
6235T1200	12"
6235T0600P	6" Reversible Jaw
6235T0800P	8" Reversible Jaw
6235T1000P	10" Reversible Jaw
6235T1200P	12" Reversible Jaw

Code	Size
AT40001	6"/150mm
AT40002	8"/200mm
AT40003	10"/250mm
AT40004	12"/300mm
AT40005	15"/380mm
AT40006	18"/450mm

Irwin Record Stillson Wrench 300 Series

- Irwin Record pipe wrenches generate superior grip, even on smooth round pipes, due to unique 'V' shaped tooth profile machined onto the jaw faces
- Gives reliability even on the toughest jobs



Code	Size
3571T0800	8" Stillson Wrench
3571T1000	10" Stillson Wrench
3571T1200	12" Stillson Wrench
3571T1400	14" Stillson Wrench
3571T1800	18" Stillson Wrench
3571T2400	24" Stillson Wrench
3571T3600	36" Stillson Wrench

Unior 492 Heavy Duty Pipe Wrenches

- Housing & handle manufactured from special alloy
- Jaws are drop forged from special carbon tool steel



Code	Size
6019T601544	8"
6019T601545	10"
6019T601546	14"
6019T601547	18"
6019T601548	24"
6019T601549	36"

Footprint Pipe Wrenches 698 Series

- Made in Sheffield
- Made from high carbon steel
- Both hook and frame teeth are machined and hardened to provide a long working life



Code	Size
4419T0700	7" Pipe Wrench
4419T0900	9" Pipe Wrench
4419T1200	12" Pipe Wrench

Unior 264 Torque Wrenches

- Reversible ratchet head
- Wrench operates clockwise and anti-clockwise directions for tightening on left and right hand threads
- Unmistakeable signal when set torque is reached



Code	Size
6010T615485	1/4" - 2-24Nm
6010T615486	3/8" - 5-110Nm
6010T615487	1/2" - 42-210Nm
6010T615488	1/2" - 35-350Nm
6010T615489	3/4" - 70-560Nm
6010T615490	3/4" - 70-700Nm
6010T615491	1" - 140-980Nm

WRENCHES



Eklind Imperial Short Series

• Short L-Key Set

13Pce - .050 - 3/8" - **Code: 10113**

11Pce - .050 - 1/4" - **Code: 10111**



Eklind Imperial Folding Set

9Pce (Hex) - 5/64" - 1/4" - **Code: 25911**

9Pce (Ball) - 5/64" - 1/4" - **Code: 25919**



Eklind Metric Short Series

• Short L-Key Set

9Pce - 1.5 - 10mm - **Code: 10509**

7Pce - 1.5 - 6mm - **Code: 10507**



Eklind Fold Up Key Set

7Pce - 1.5 - 6mm - **Code: 25171**

6Pce - 3 - 10mm - **Code: 25161**

7Pce - 1.5 - 6mm - **Code: 21171**

9Pce Ergo-Fold - 5/64" - 1/4"

- **Code: 25911**



Eklind Metric Ball End Set

9Pce (Ball) - 1.5 - 10mm - **Code: 13609**



Eklind Ball Twin Packs

Ball Point Twin Pack - **Code: 29016**

Ball End Twin Pack - **Code: 29022**



Individual Sizes Also Available
On All Eklind Keys

Eklind Long Arm Hex Key Set

13Pce (Imp) - .050 - 3/8" - **Code: 10213**

9Pce (Met) - 1.5 - 10mm - **Code: 10609**

8Pce Ergo-Folding - 2 - 8mm - **Code: 25181**



Unior Hexagon AF-T Handle Wrench

Code: 193HX



Unior Ball Ended AF-T Handle Wrench

Code: 193HXS



Irwin Record Chain Pipe Wrench

- Robust construction
- 233C - Approx 30" Handle
- 234C - Approx 42" Handle



Code	Size
3574T0200	5/16" - 2" Capacity
3574T0300	5/16" - 3" Capacity
3574T400	1/4" - 4" Capacity
3574T0800	1" - 8" Capacity

Irwin Record Handi wrench

- 4" Handi wrench
- Drop forged handle
- Simply loop the chain around the pipe, lock it and the jaws will grip in the direction of the turn
- The pipe can then be easily tightened or loosened with short strokes of the handle

Code: **3576T0400**



Unior 206 Chain Wrench

- Chrome plated
- Provides maximum grip on round and irregular shapes
- Essential when turning pipes in trenches or close to walls
- Chrome Vanadium

Code: **6012T0280**



Unior Flexible Hook Wrench 255F

- Chrome vanadium material
- Chrome plated surface finish according to EN12540
- Entirely hardened and tempered

35 -50mm - Code: **6009T615028**
 50 -80mm - Code: **6009T615029**



Unior 205 Strap Wrench

- Material Chrome Plated
- Will grip almost any shape or material
- Immense leverage can be applied to the workpiece without scratching
- Chrome vanadium

60 - 140mm - Code: **6011T0280**



Carolus 1/2" Torque Wrench

- Controlled screw tightening
- For use in all areas of industrial manufacturing
- Adjustable torque wrench with square drive and integrated ratchet-head function
- For controlled bi-directional tightening
- Actuation accuracy: +/-3% tolerance of the scale set torque
- Dual scale Nm and lbf ft

10-100Nm - Code: **4989T01210100**
 20-200Nm - Code: **4989T01220200**
 60-300Nm - Code: **4989T01260300**



Bahco Stillson Type Pipe Wrench

- Professional Stillson type pipe wrench
- Forged from high quality steel
- Both jaws have deep grooves ensuring instant grip and ratcheting action
- Can be used with Copper, Aluminium, Ferrous and Non-ferrous metals

8" - Code: **6295T3618**
 10" - Code: **6295T36110**
 12" - Code: **6295T36112**
 14" - Code: **6295T36114**
 18" - Code: **6295T36118**
 24" - Code: **6295T36124**



Leica
 Geosystems

The New Leica Range Now In Stock.





TERMS & CONDITIONS: Please note that whilst every care has been taken in the production of this publication, the publishers cannot be held responsible for any errors and omissions. All images are provided for illustration purposes only. E&OE.

